









 Ø8 x 35	 8x	 Ø8 x 24	 8x	 16x	 5x	 Ø3,5 x 16 24x	 8x
 8x	 2x	 8x	 8x				

<p>1 1857×450×18 1x</p>	<p>3 850×450×18 1x</p>
<p>2 1857×450×18 1x</p>	<p>6 813×402×18 3x</p>
<p>7 403,5×1853×18 1x</p>	<p>9 850×450×18 1x</p>
<p>8 403,5×1853×18 1x</p>	
<p>5 1873×829×18 1x</p>	

1



2

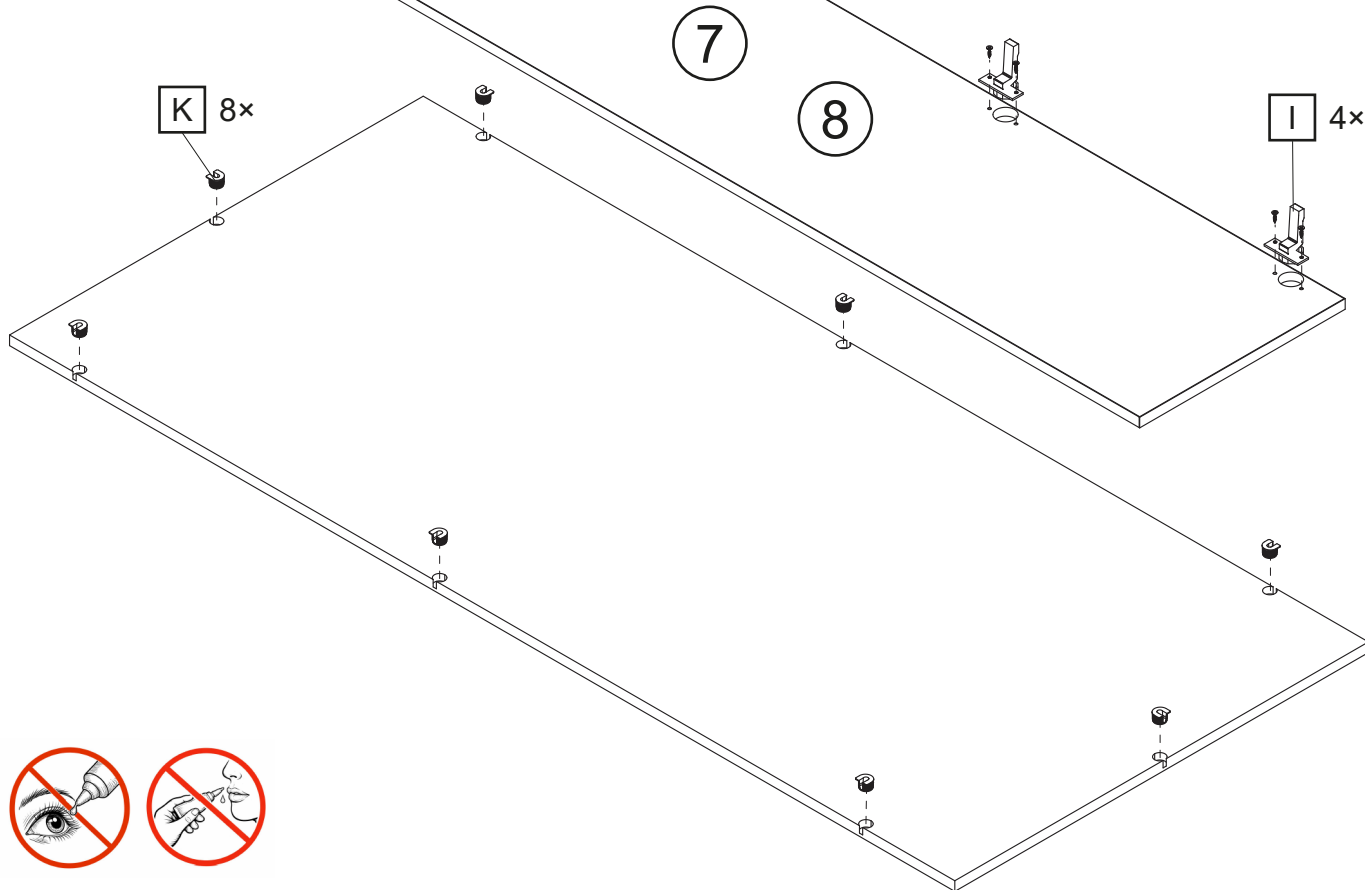
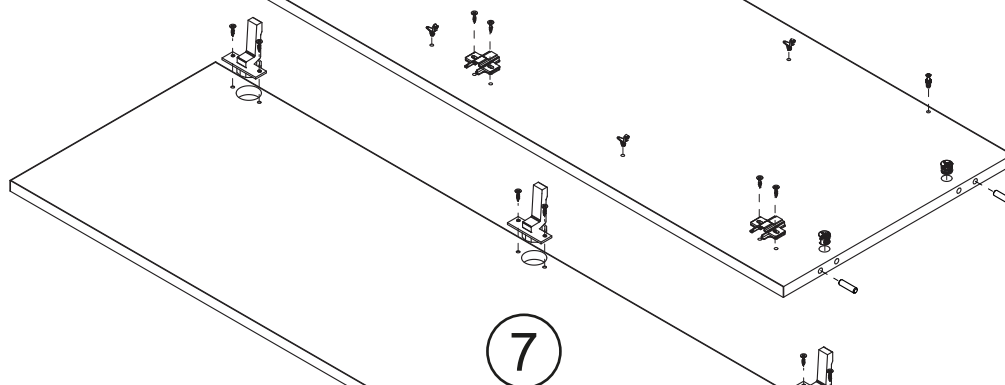
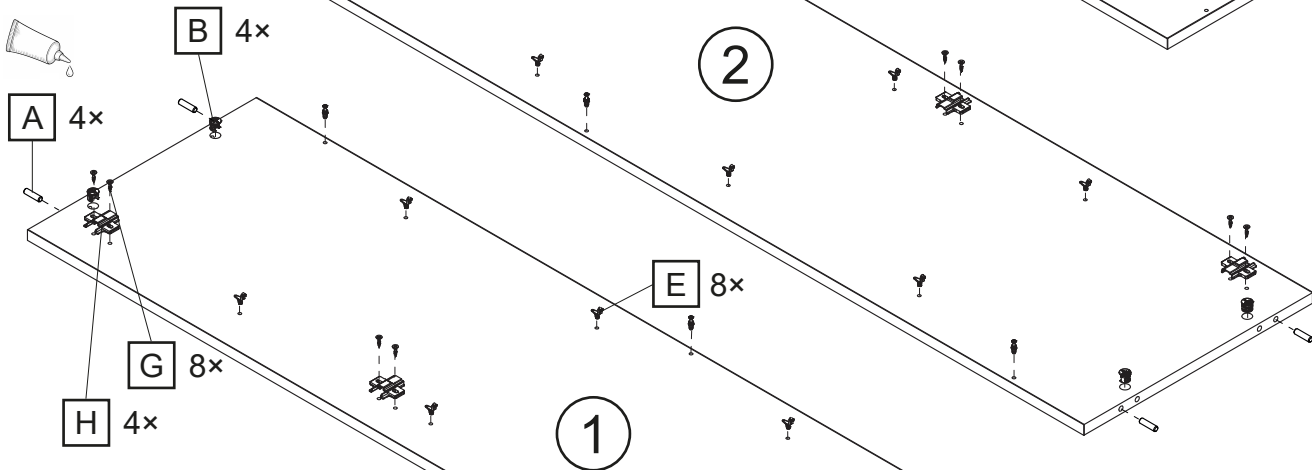
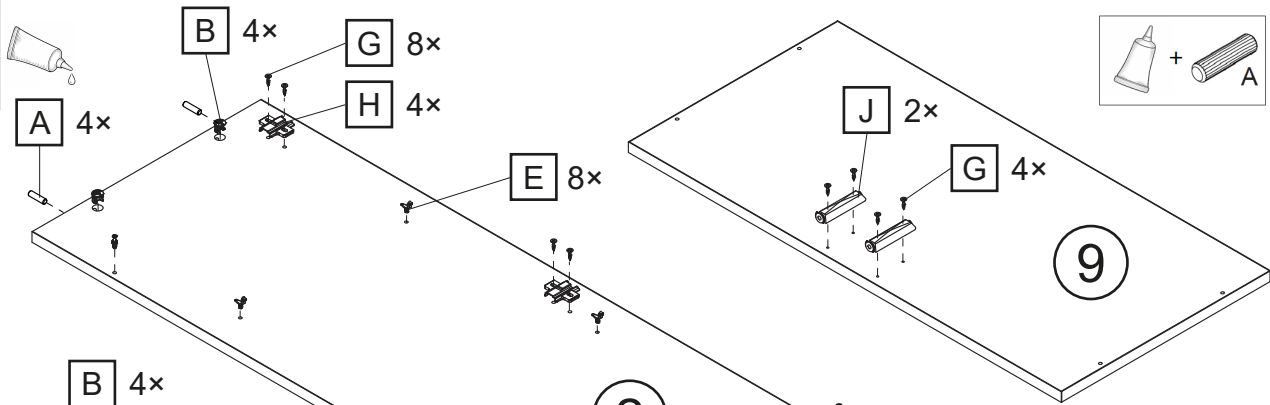
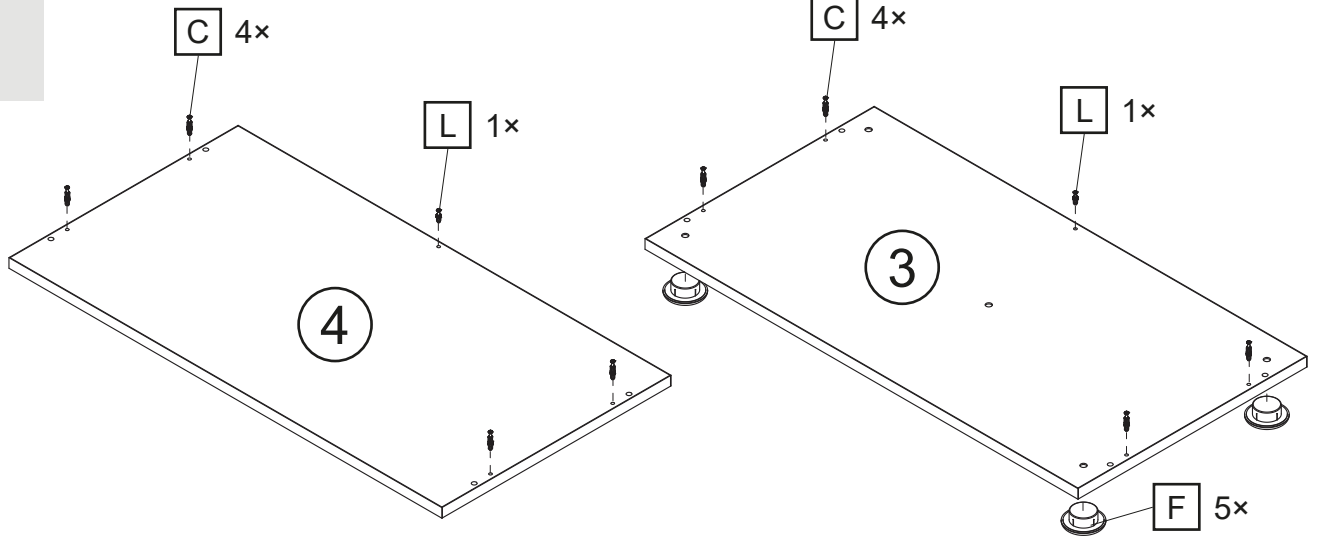

3

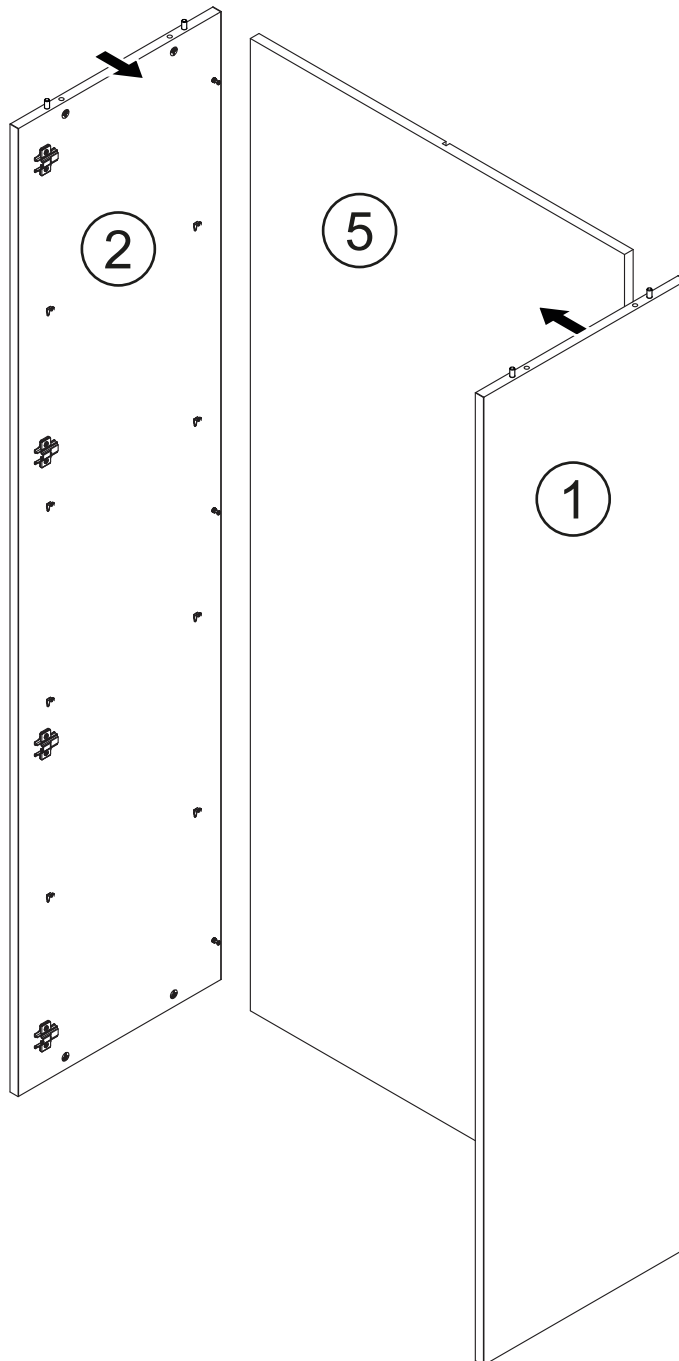

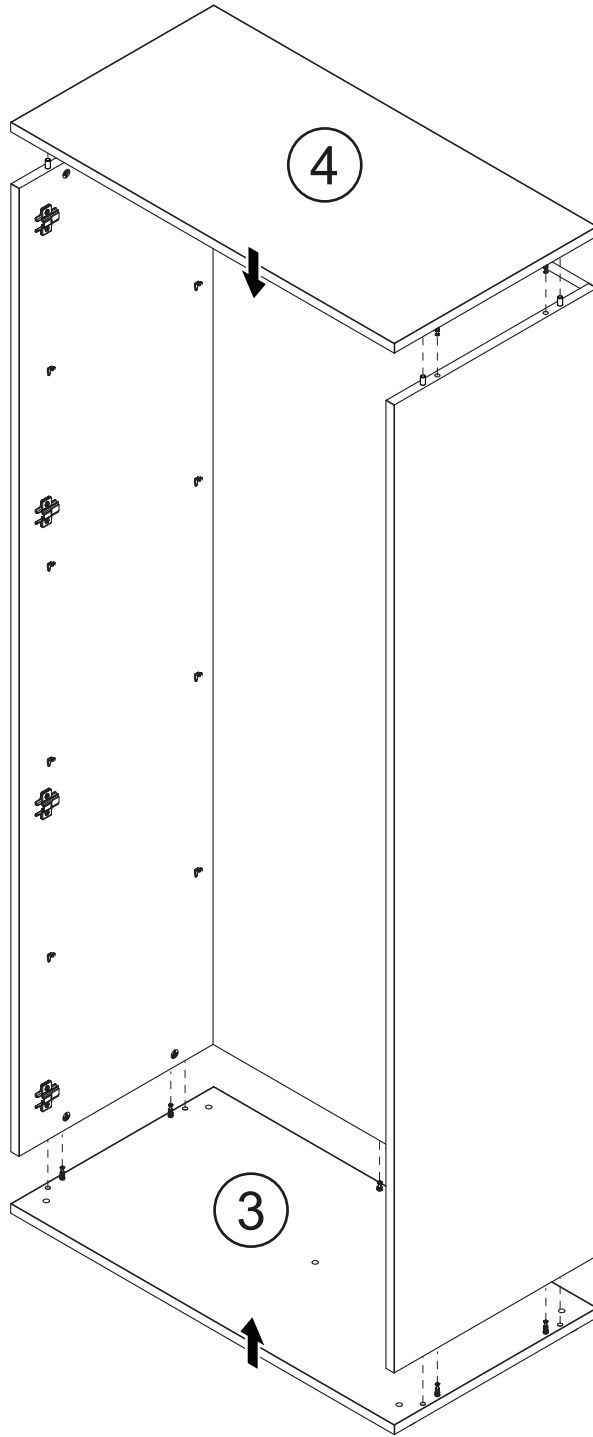

5

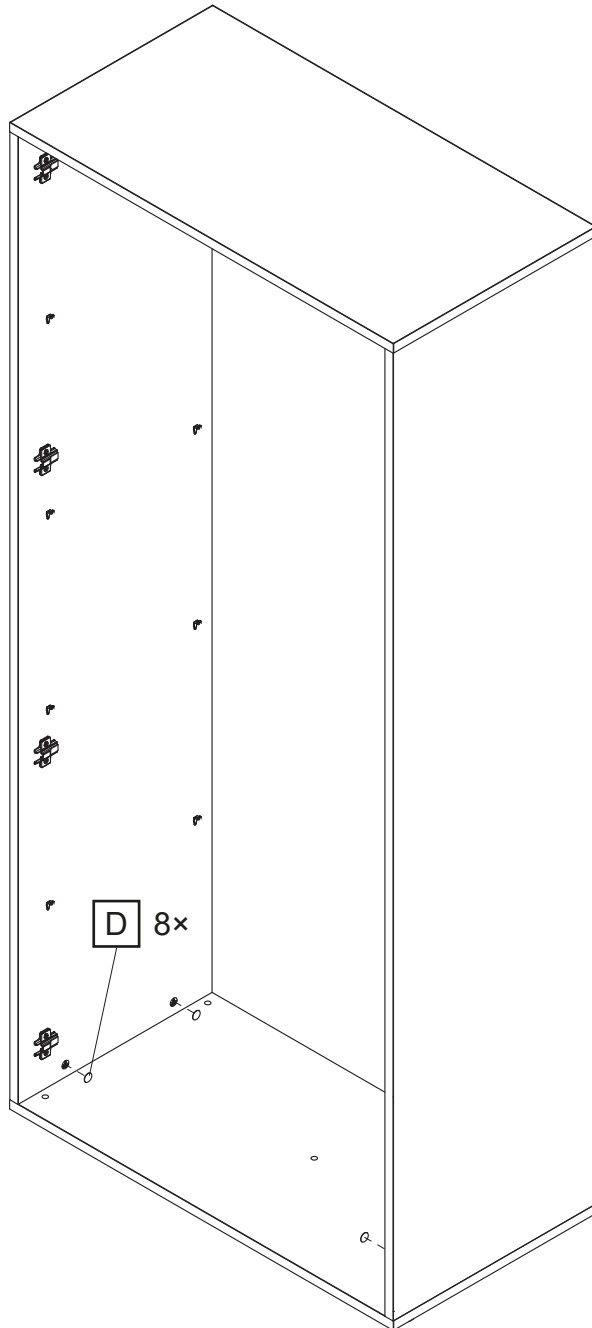

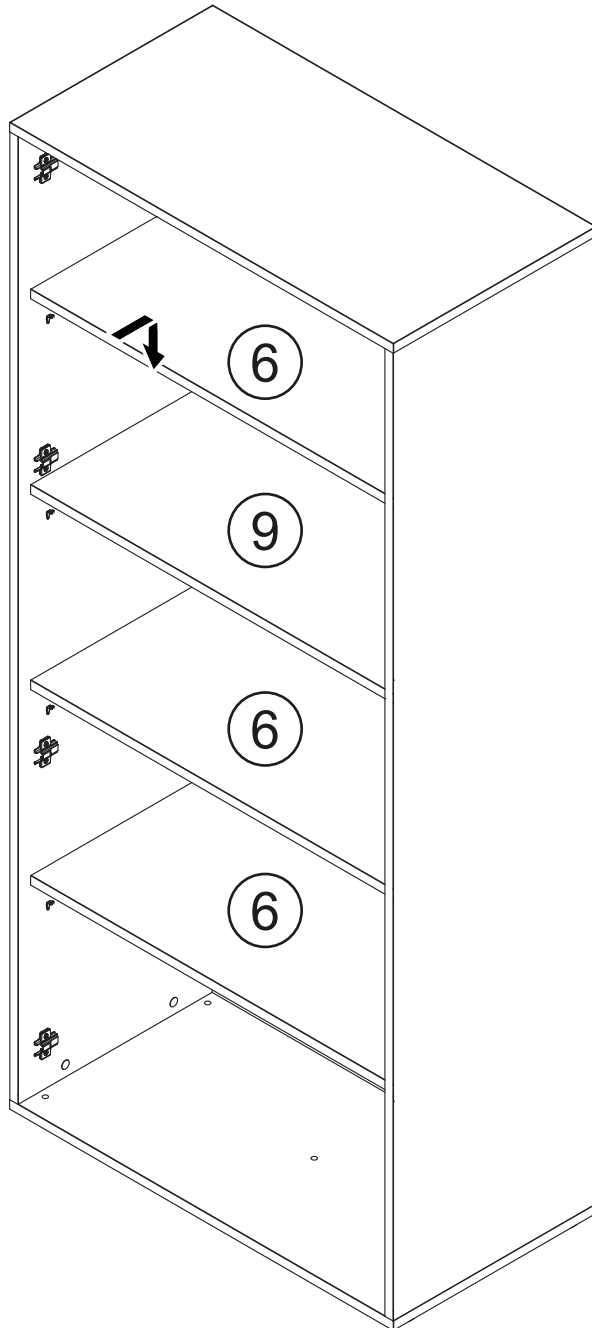

7

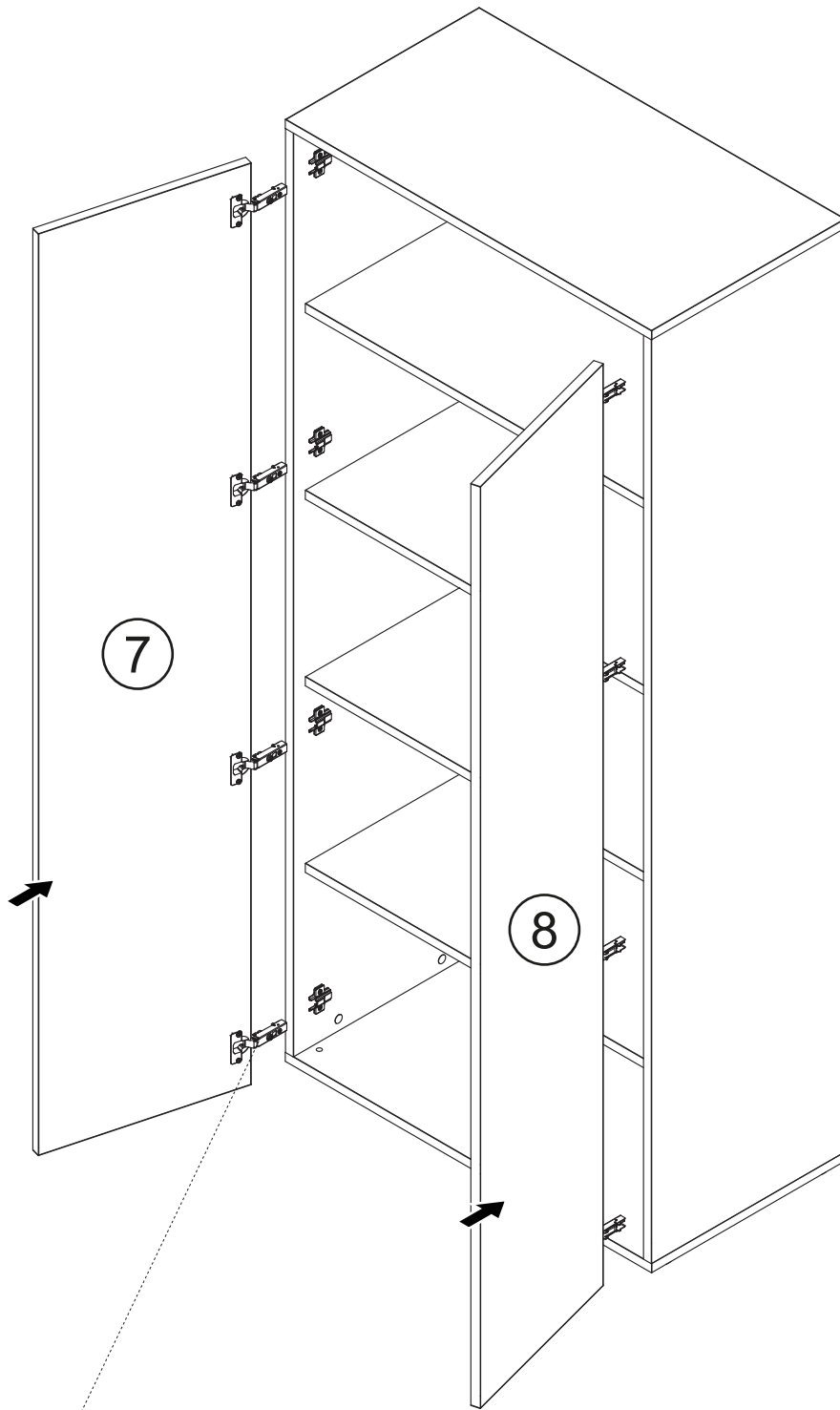

1

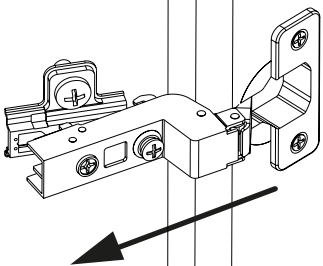

2

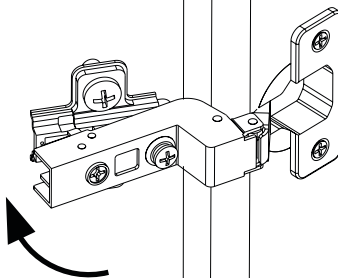

3

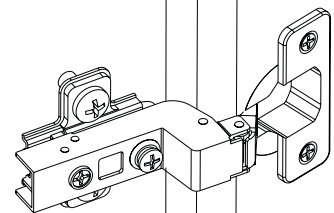

7

