









 Ø8 × 35	 8x	 Ø8 × 24	 8x	 Ø3,5 × 16	 4x	 16x	 16x
A 18x	B 8x	C 8x	D 8x	E 2x	F 4x	G 16x	H 16x
 1x	 Ø5 × 50	 2x	 Ø6 × 30				
I 1x	J 2x	K 2x	L 5x				



1



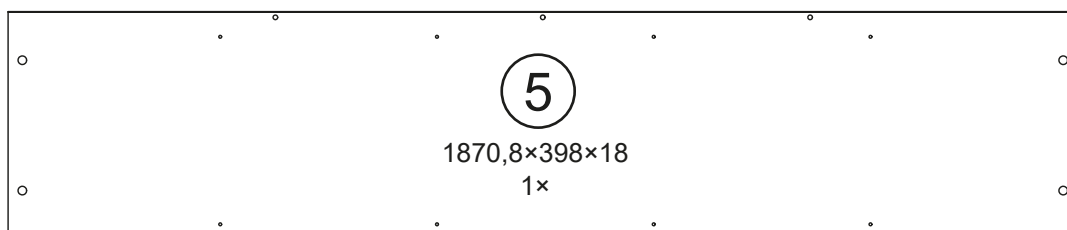
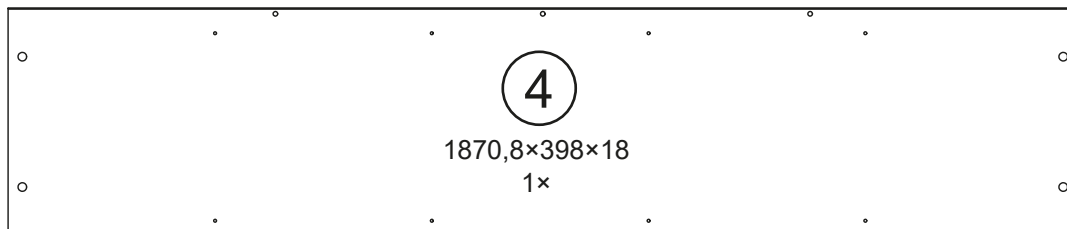
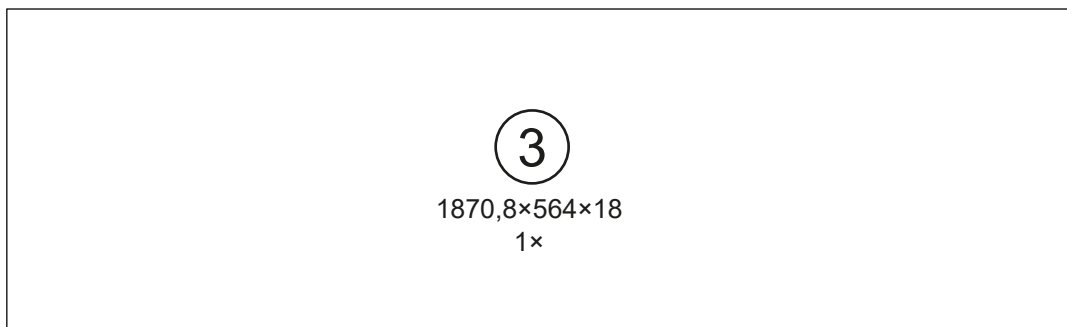
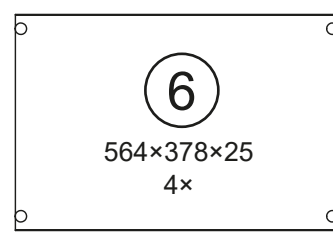
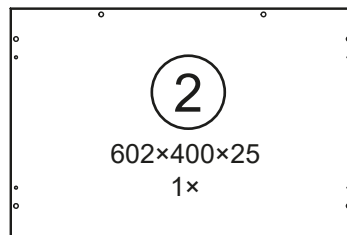
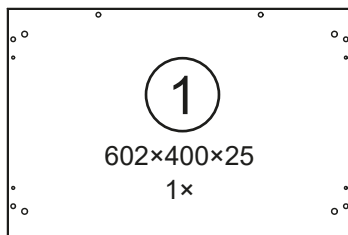
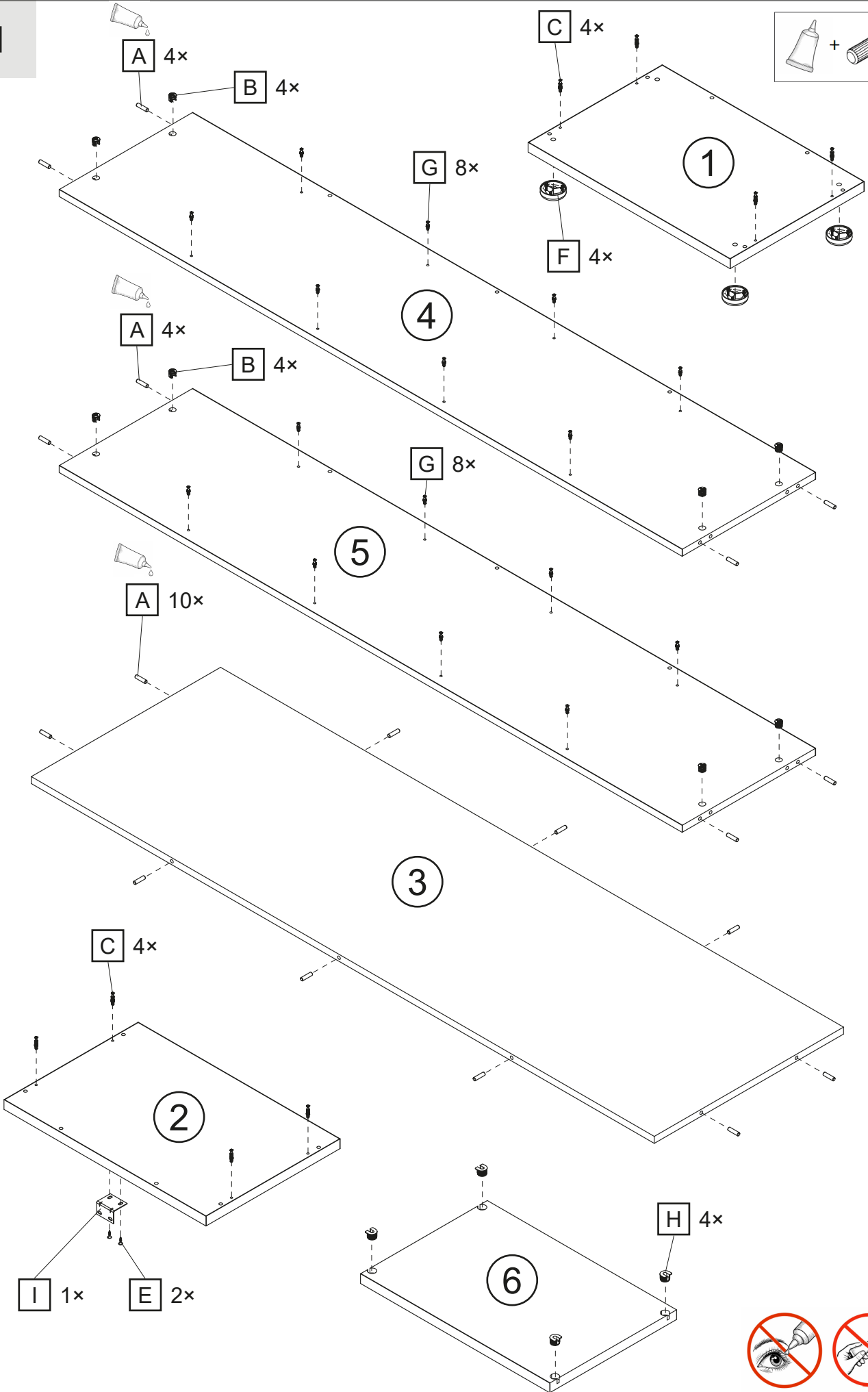
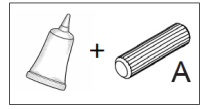
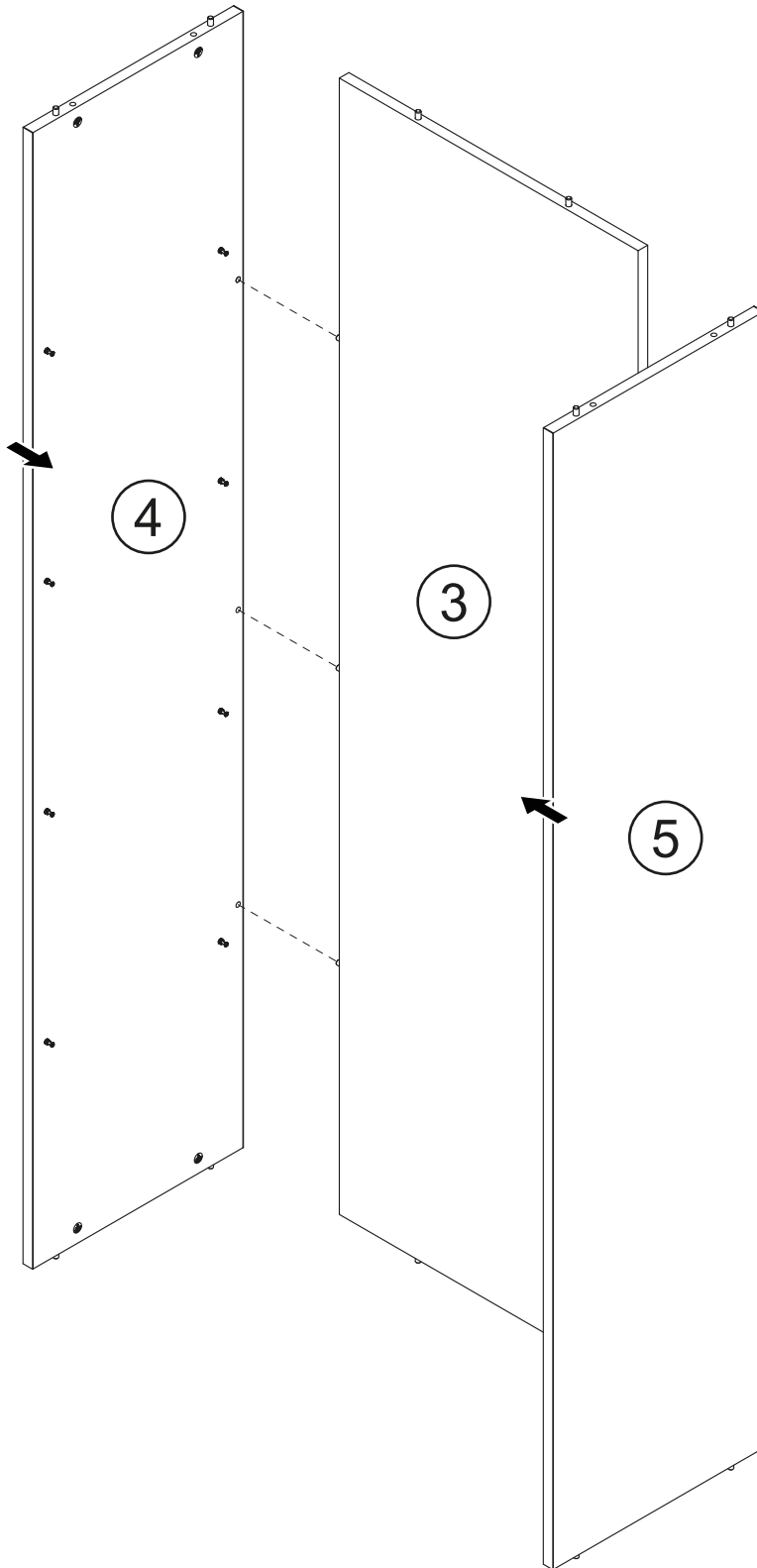

3

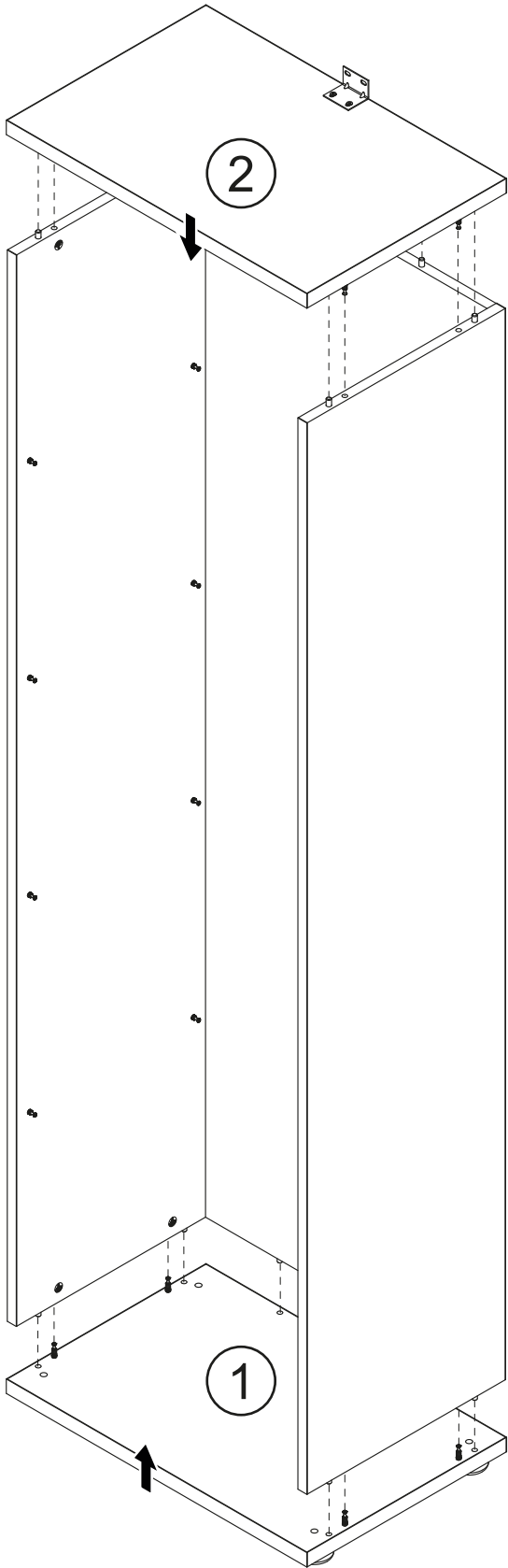

4

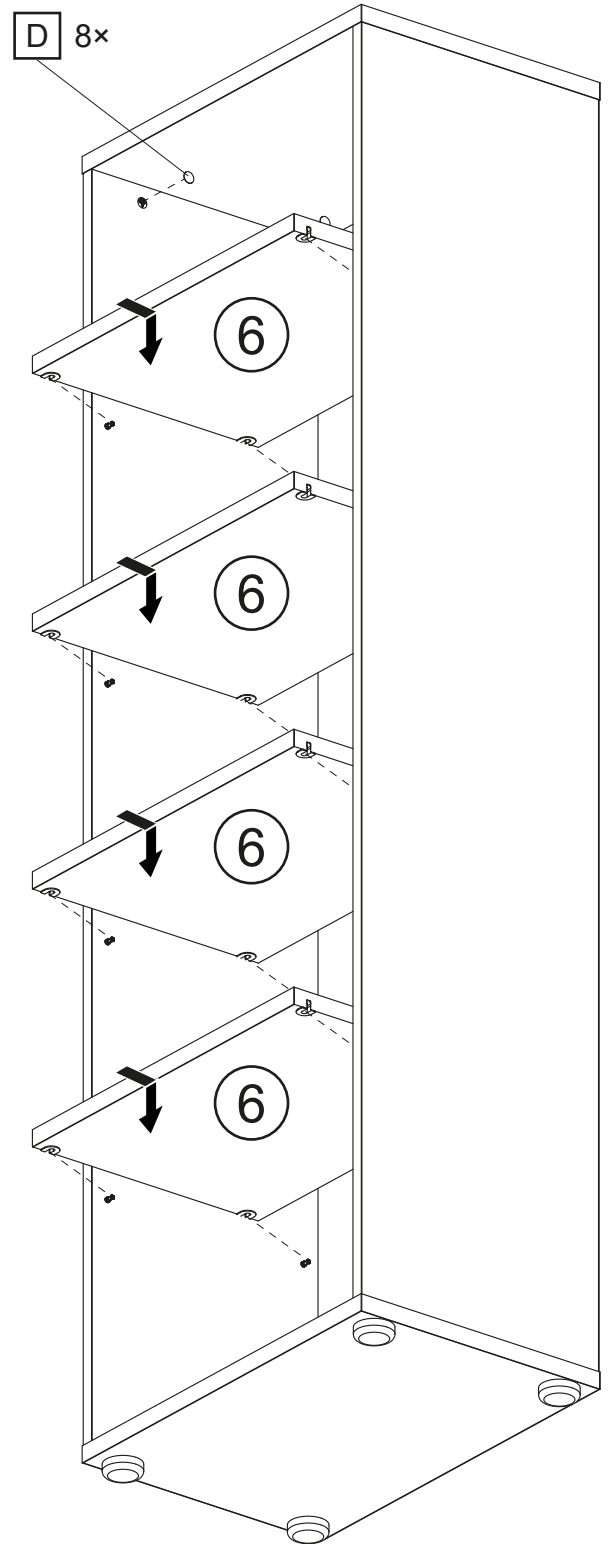

5

