







 Ø8 × 35		 Ø8 × 24		 Ø3,5 × 16			
A 22×	B 8×	C 8×	D 8×	E 8×	F 2×	G 5×	H 2×
							
I 2×	J 1×						



1



2

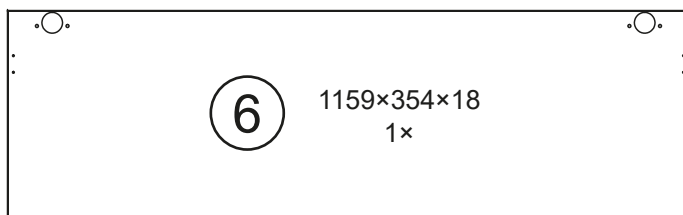
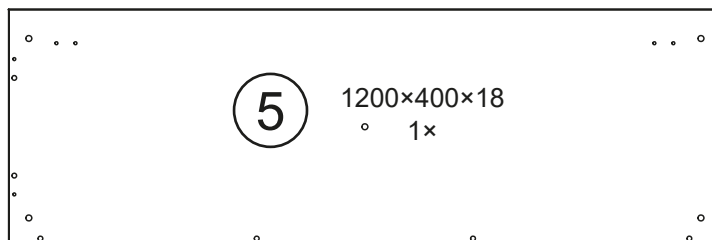
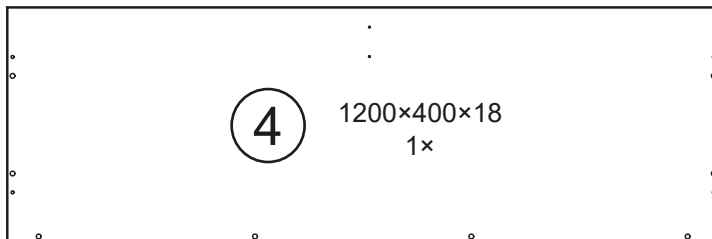
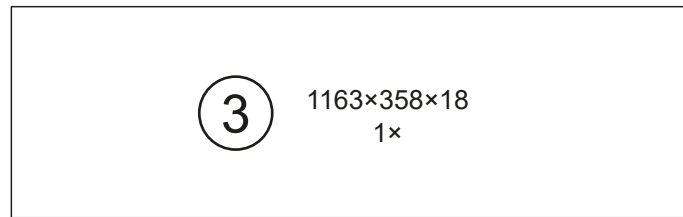
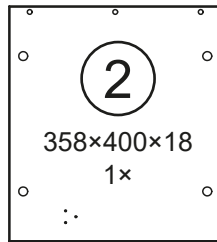
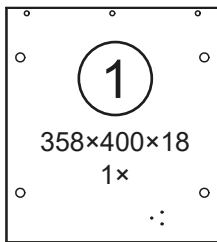
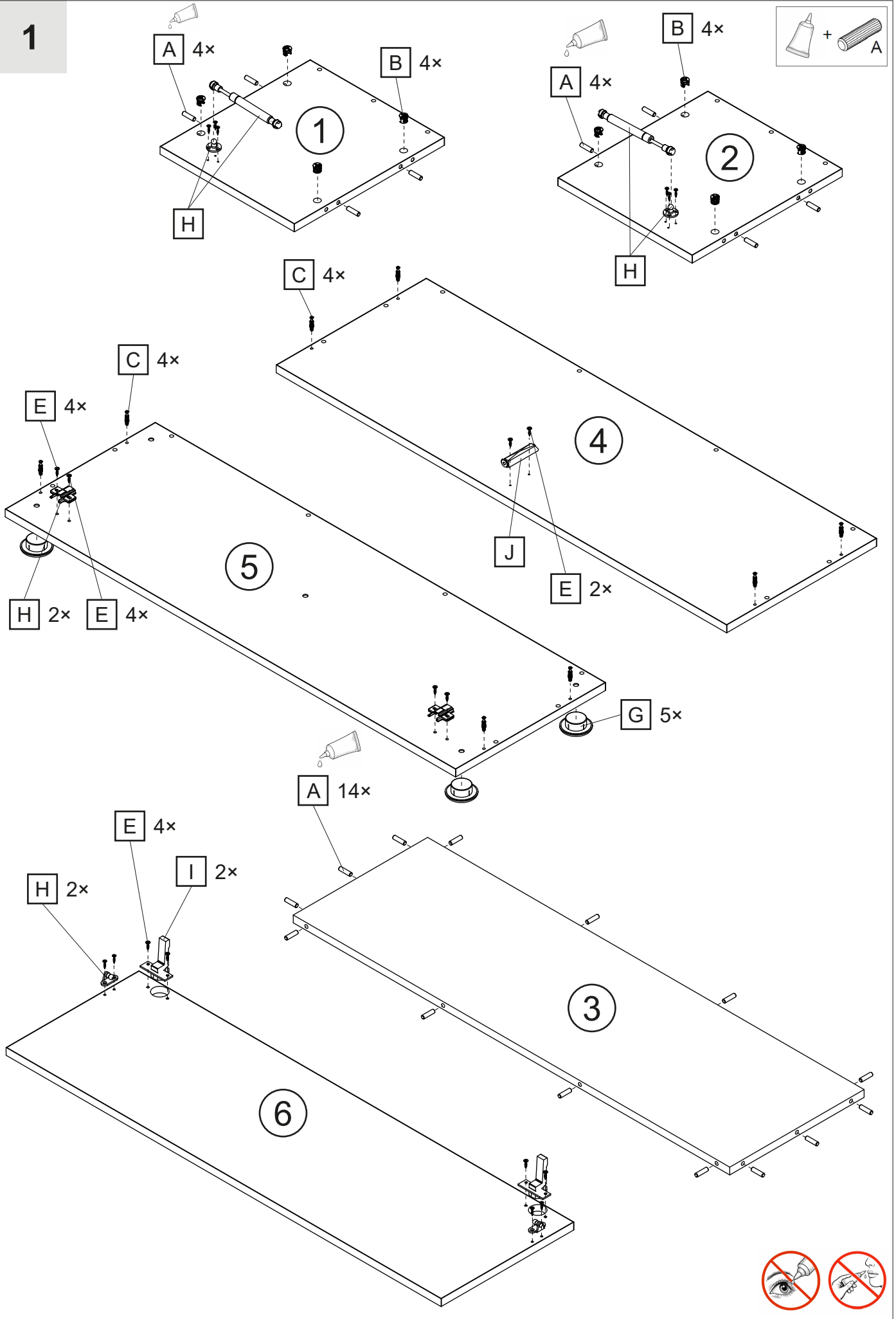
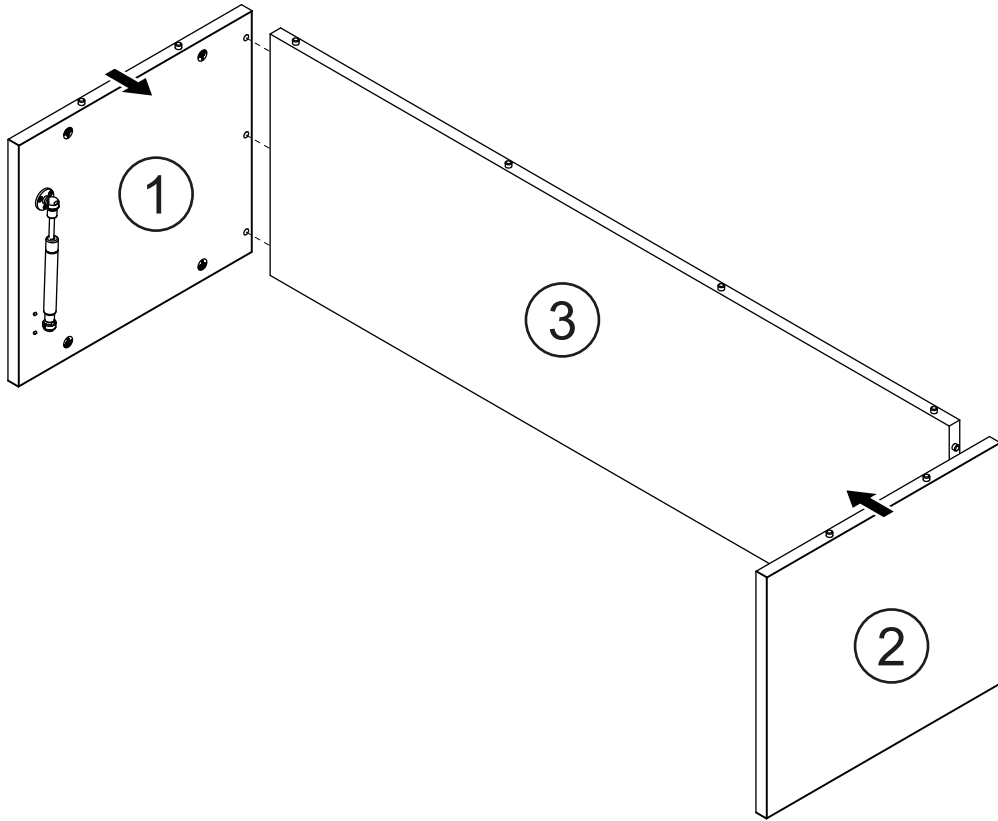

3



4

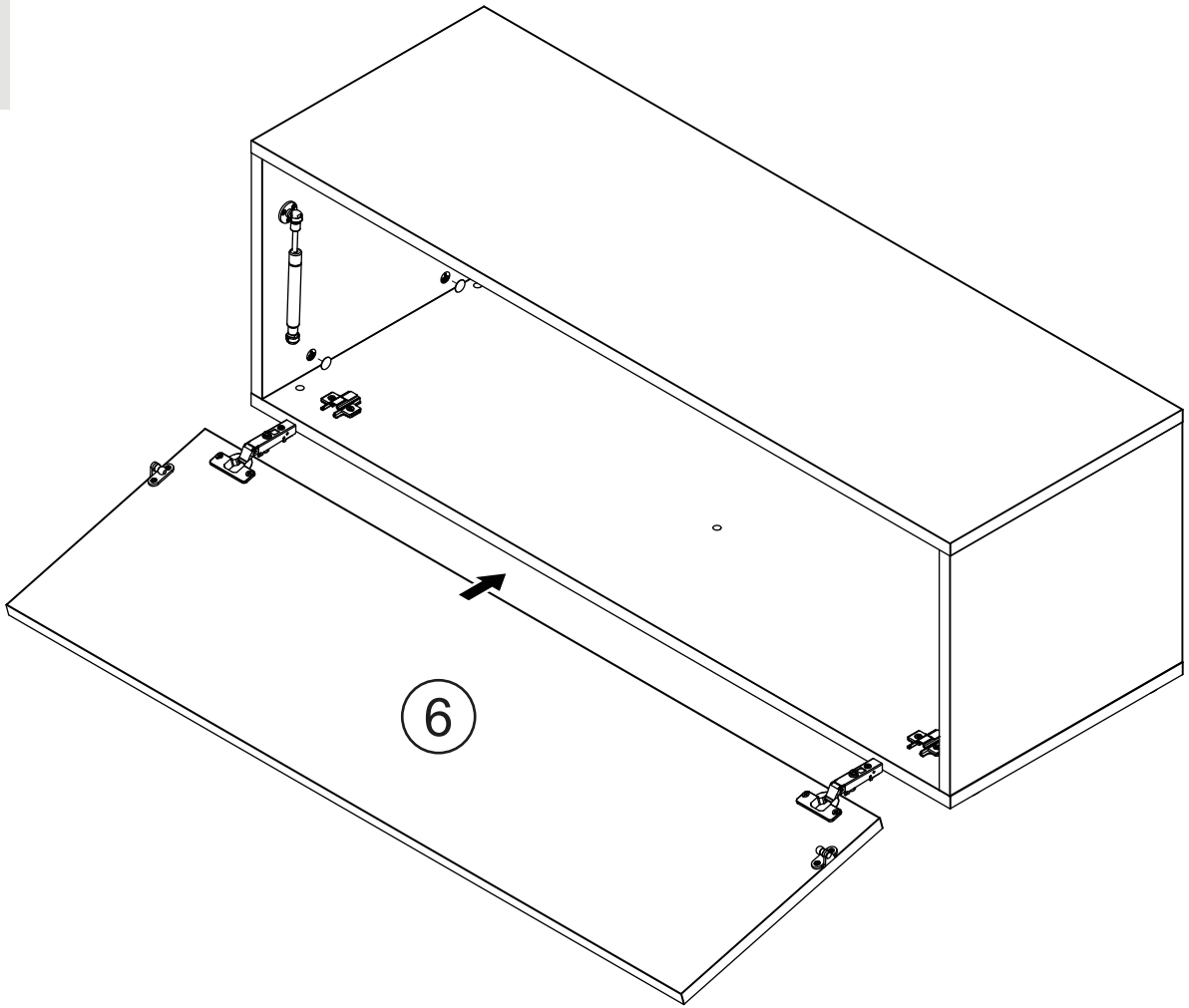

5

