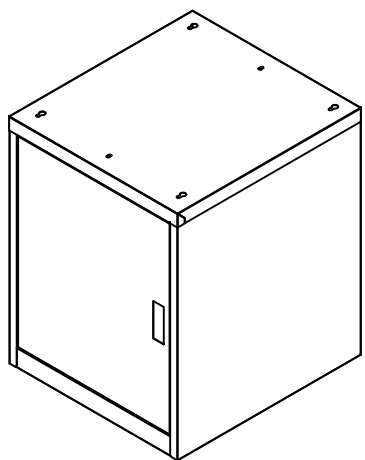
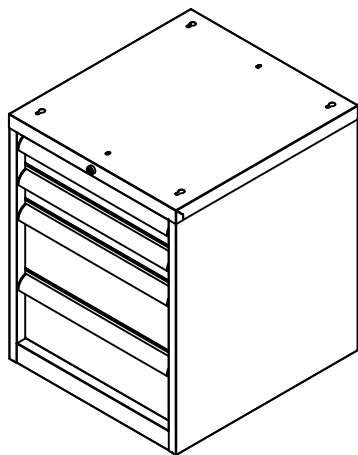
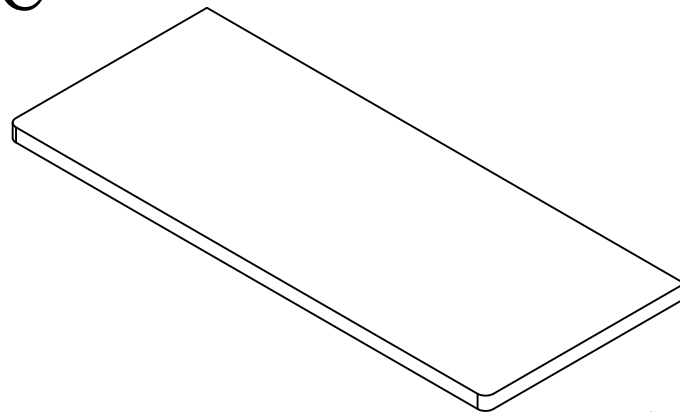

A

1Pc

B

1Pc

C

1Pc

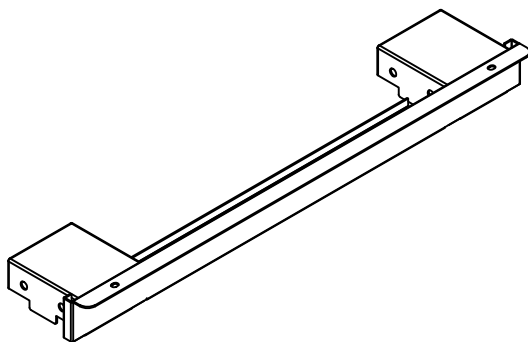
D

2Pcs

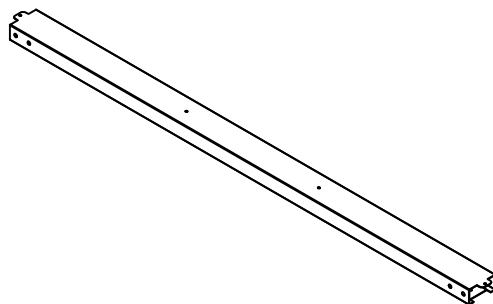
E

2Pcs

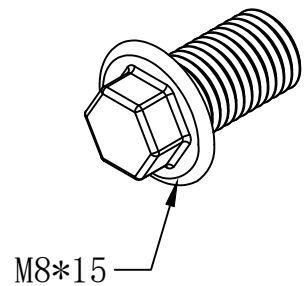
a

M8*15

8Pcs

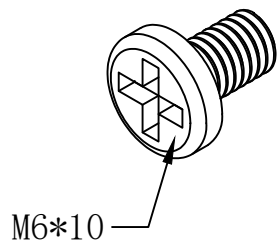
b

M6*10

10Pcs

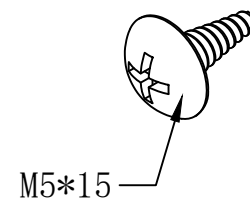
c

M5*15

8Pcs

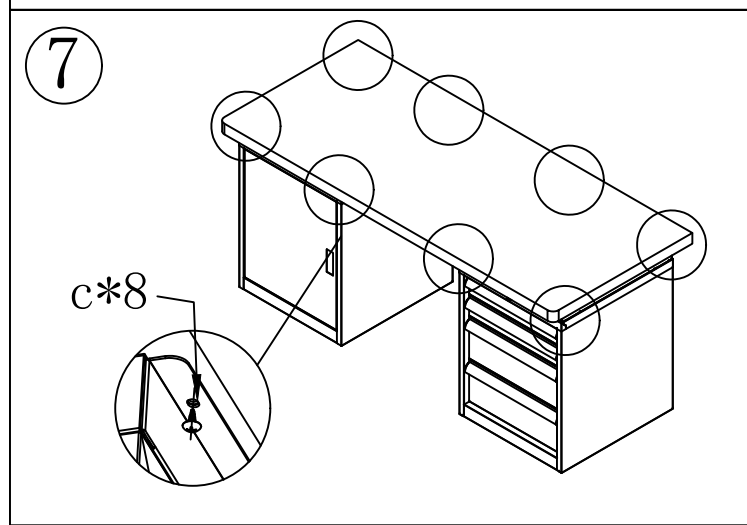
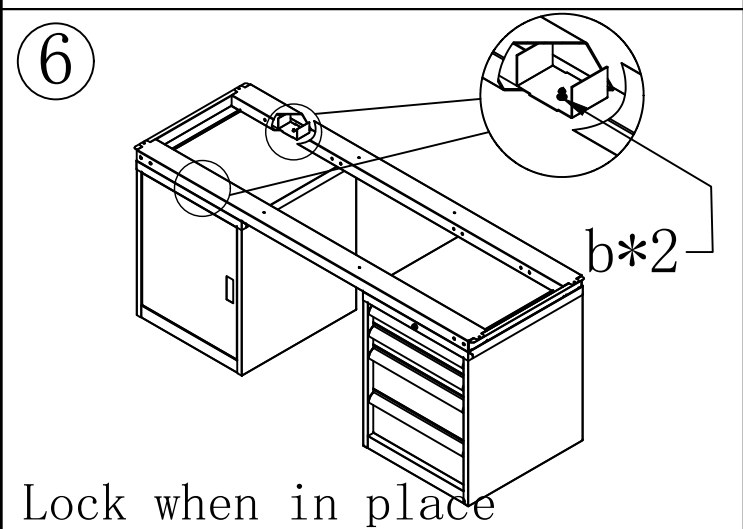
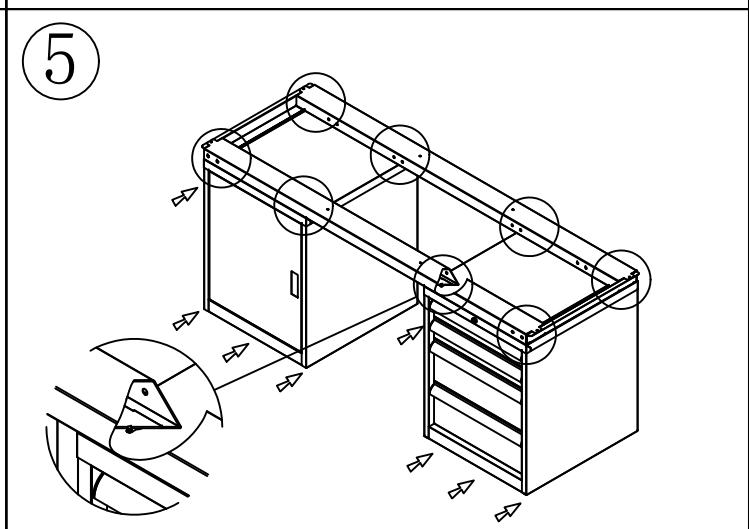
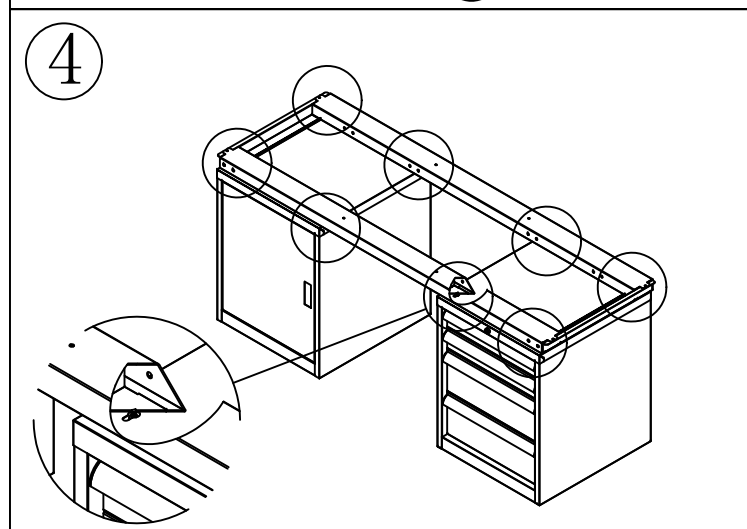
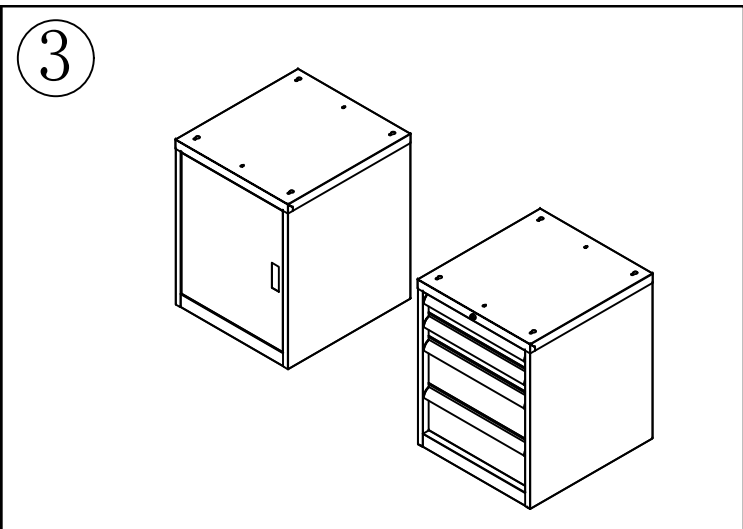
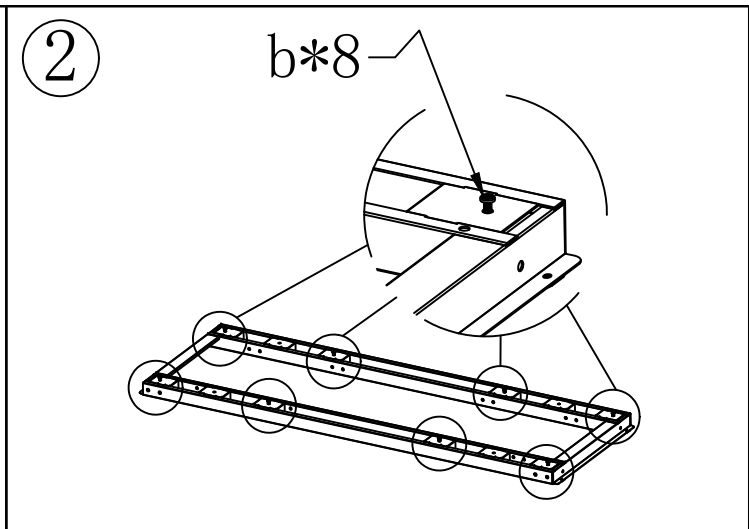
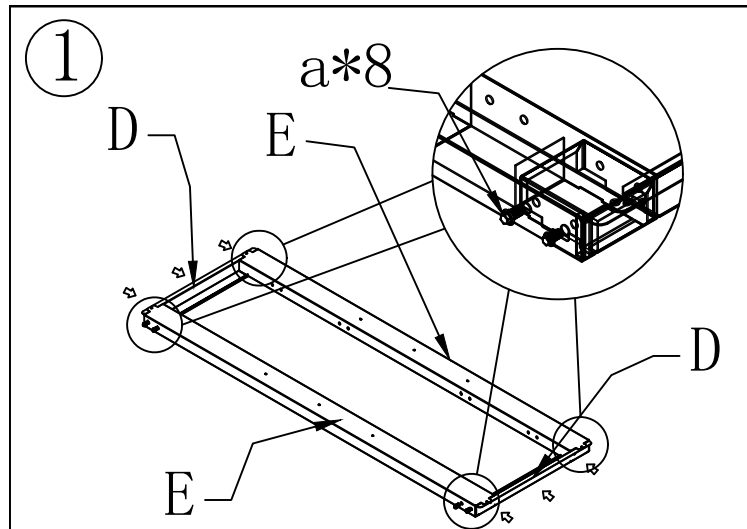

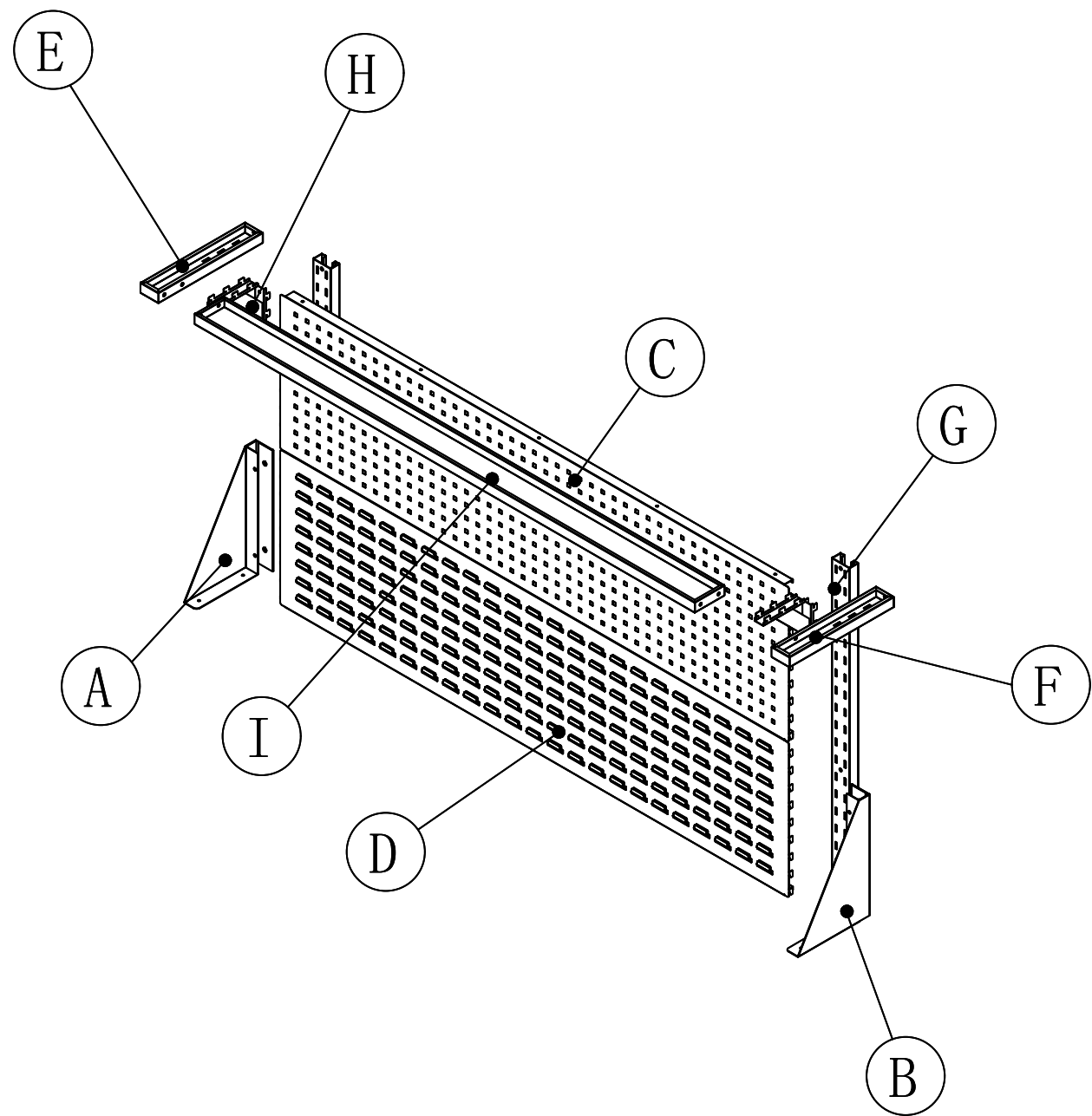
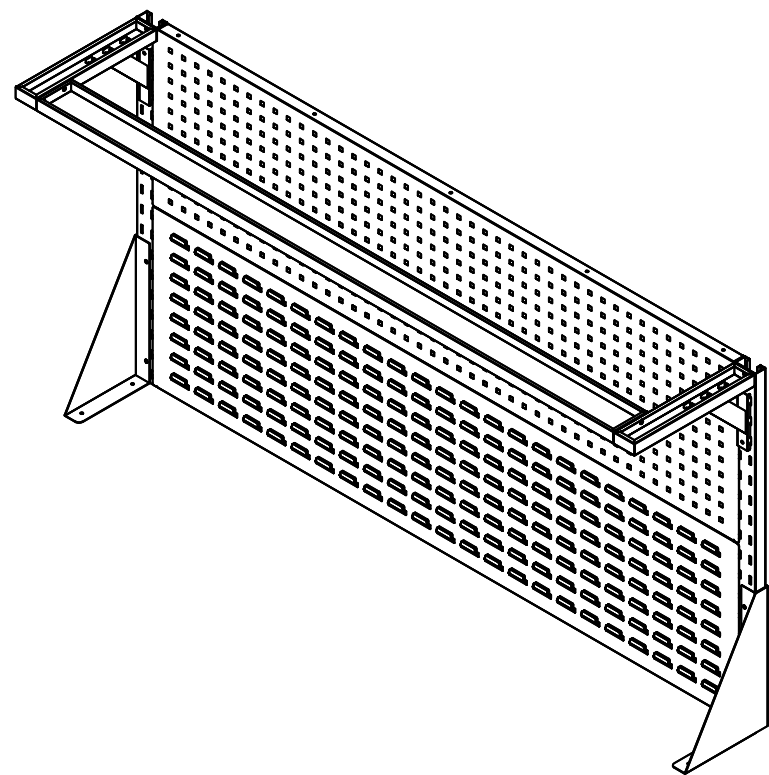

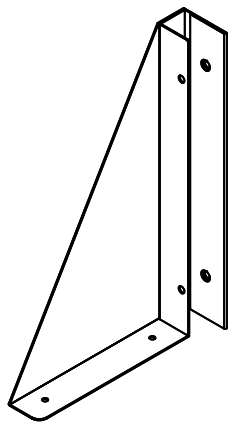
A

1Pc

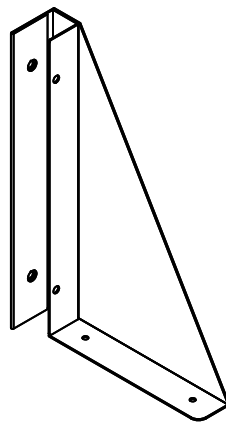
B

1Pc

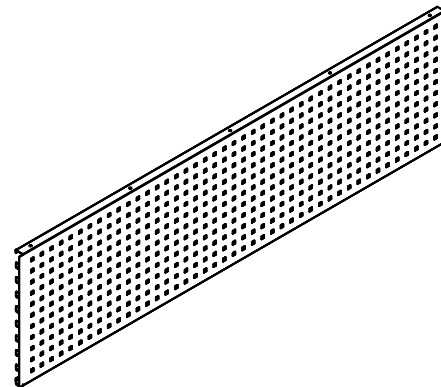
C

1Pc

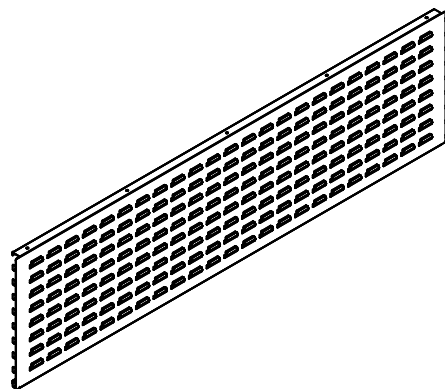
D

1Pc

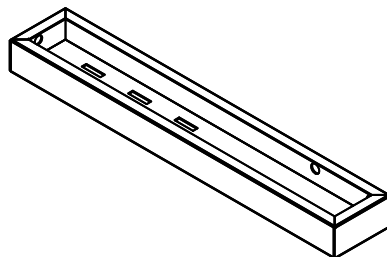
E

1Pc

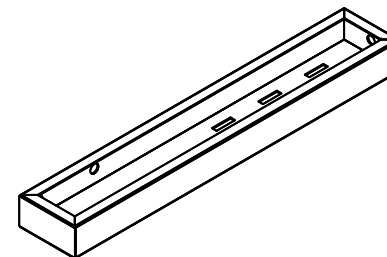
F

1Pc

G

2Pcs

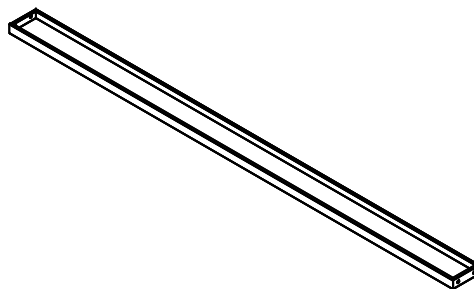
H

1Pc

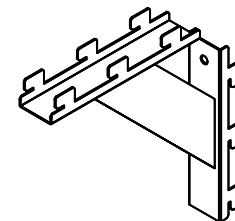
I

2Pcs

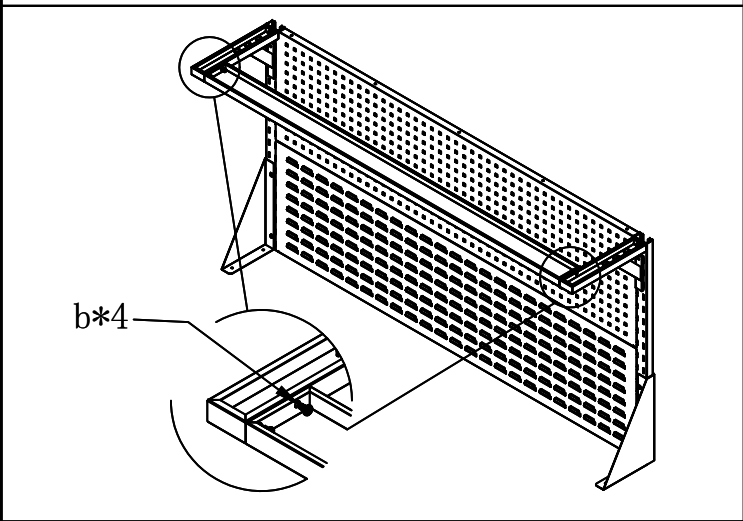
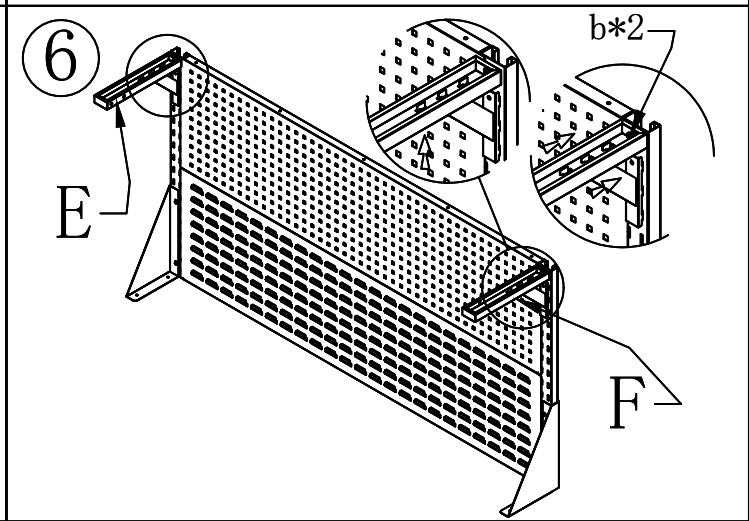
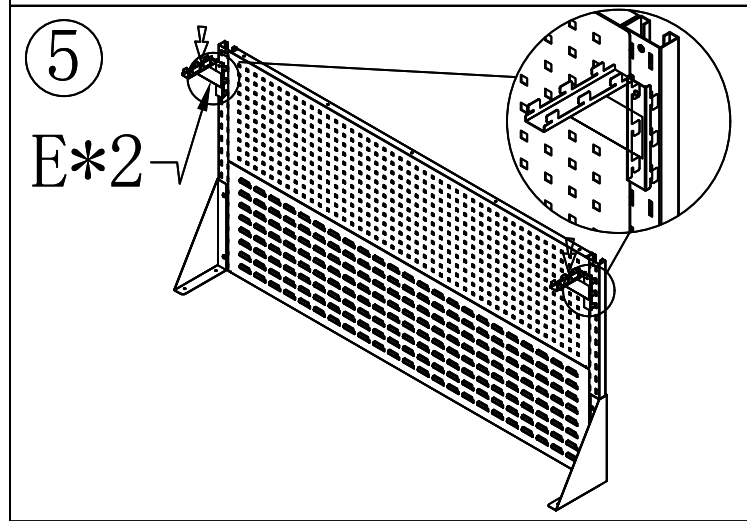
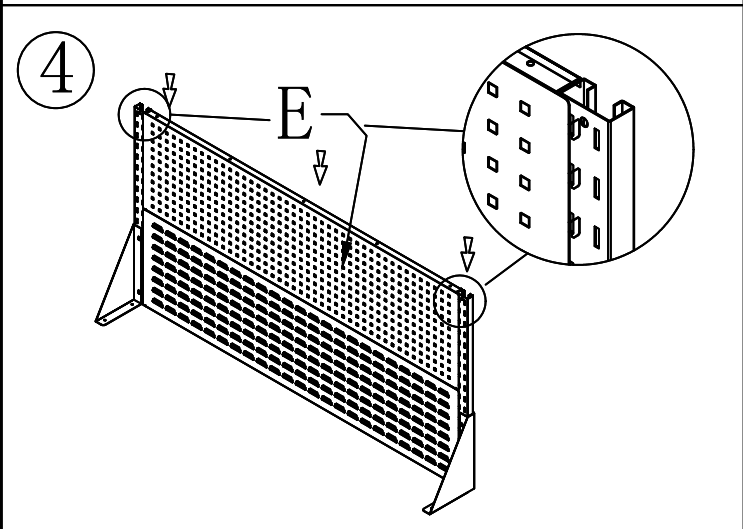
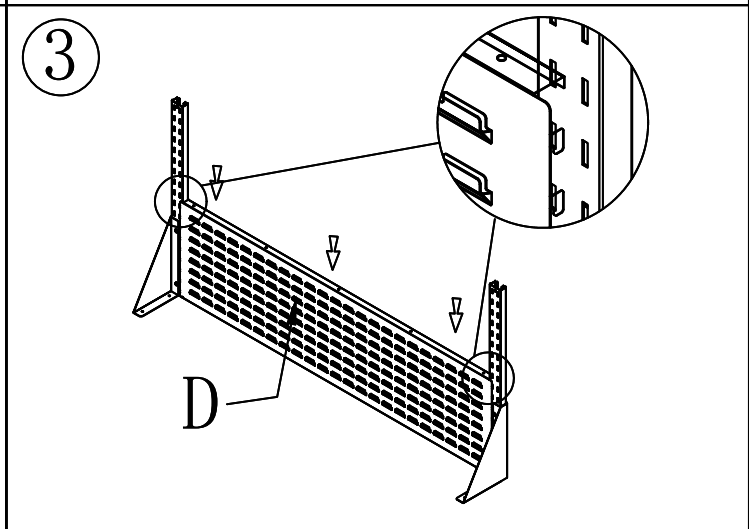
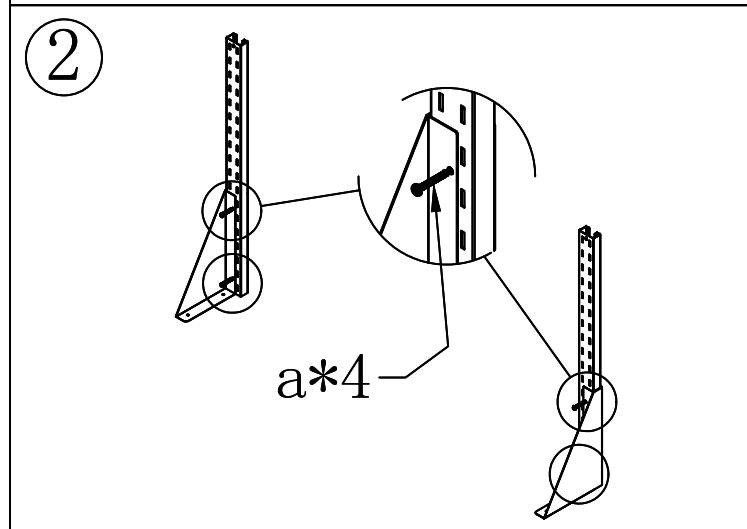
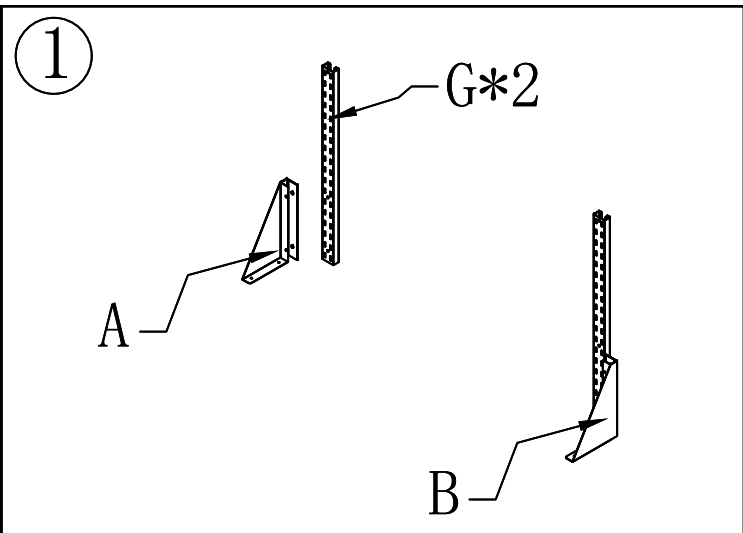
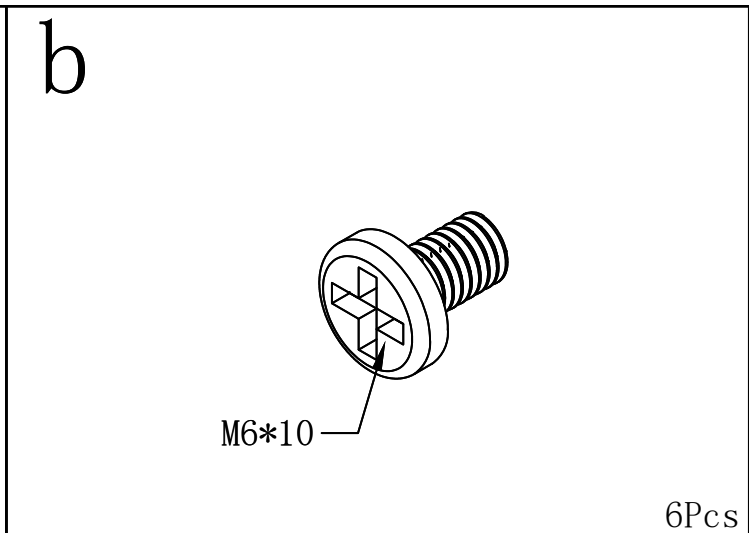
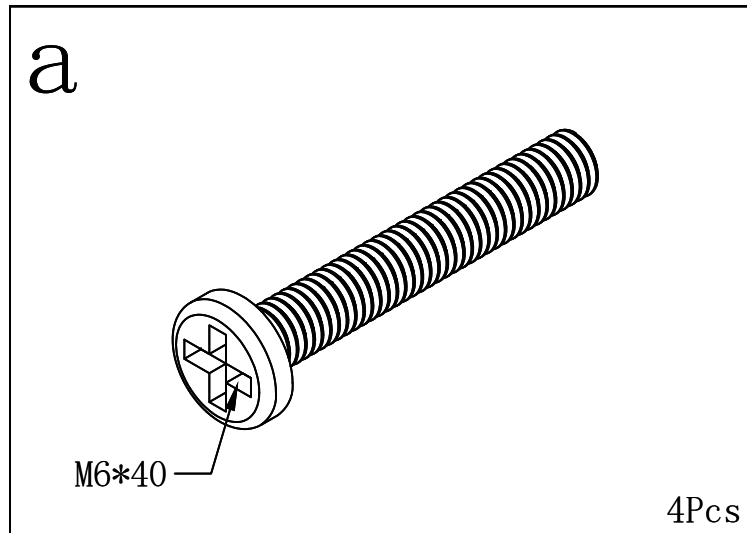

Z

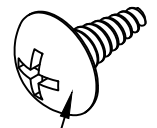

M5*15

9Pcs

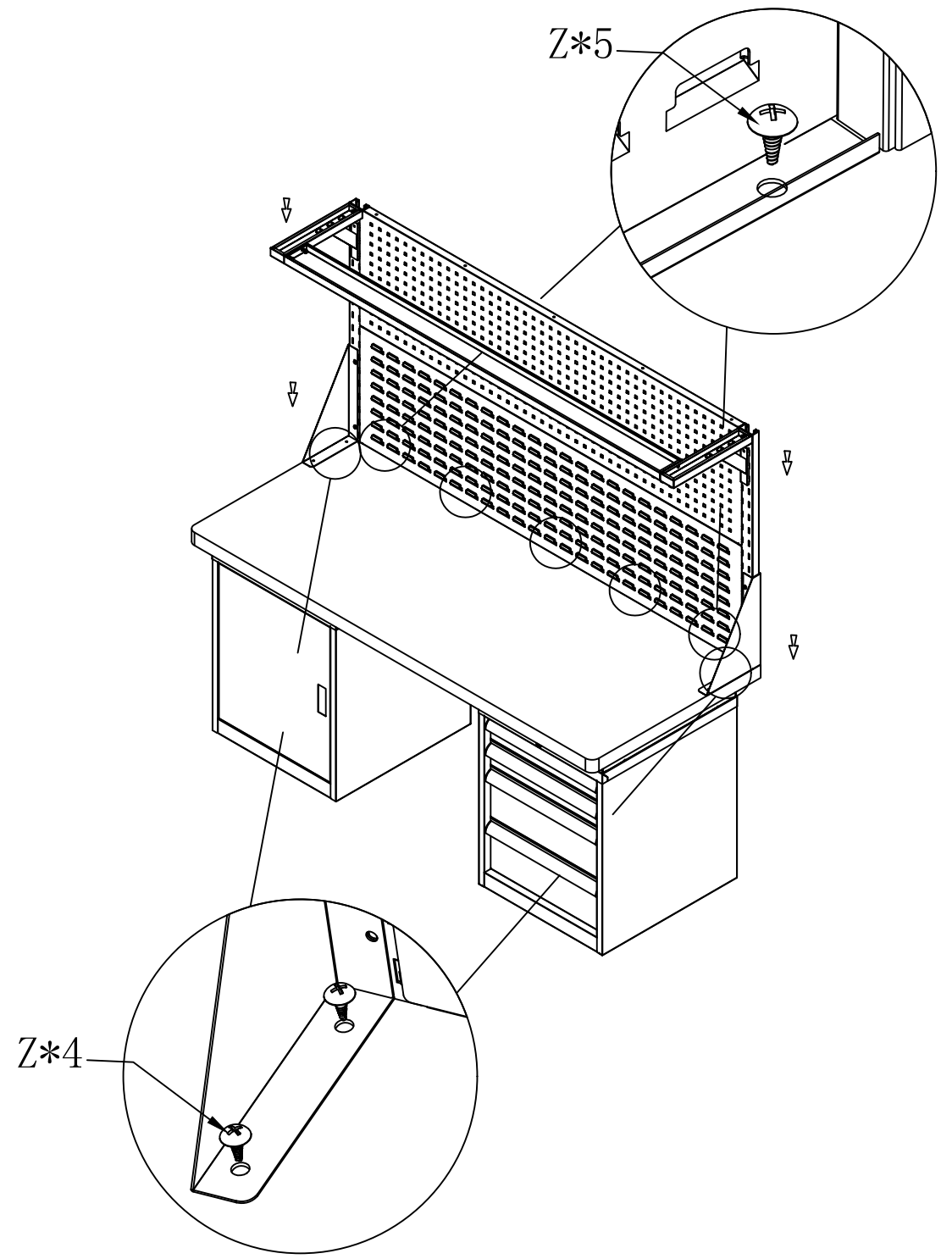
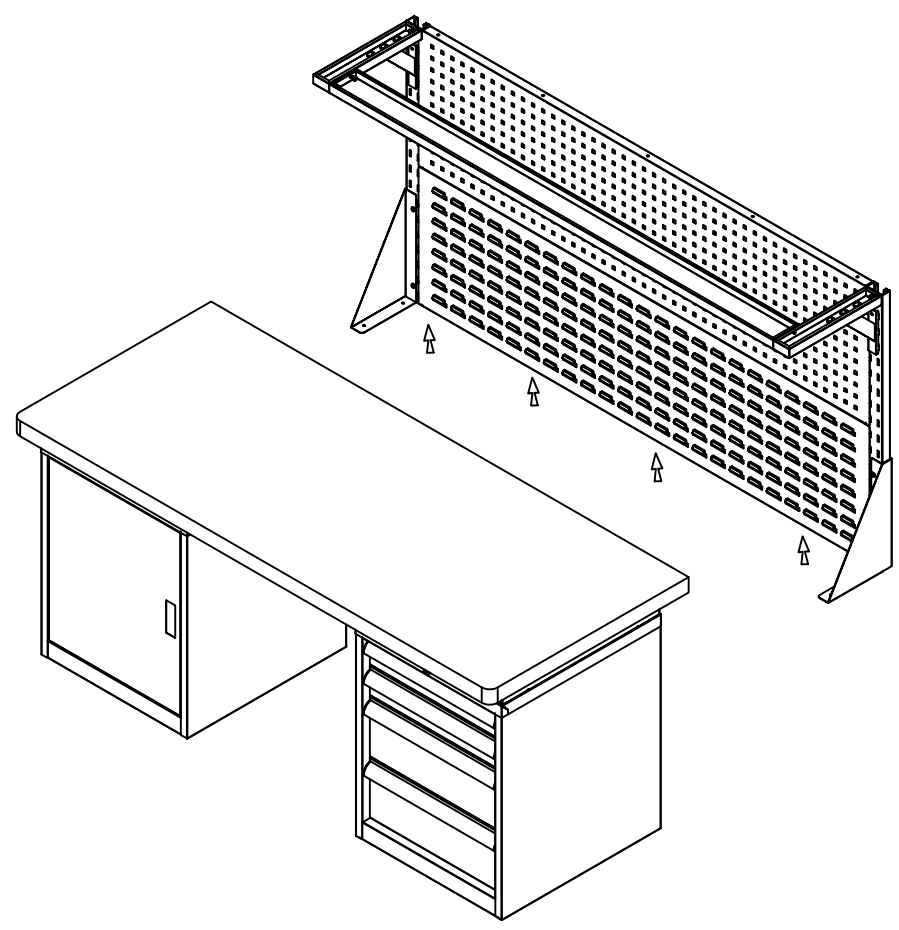

Z*5

Z*4