



Ø8 × 35		Ø8 × 24			Ø3,5 × 16		
A 40×	B 40×	C 40×	D 40×	E 12×	F 12×	G 5×	H 6×
							
I 4×	J 3×	K 2×					

 <p>1 718,4×361×18 1×</p>	 <p>2 718,4×361×18 1×</p>	 <p>5 700,4×358×18 1×</p>	 <p>8 505,3×358×18 2×</p>
 <p>3 1564×358×18 1×</p>		 <p>9 532,3×736,4×18 2×</p>	 <p>10 531,3×736,4×18 1×</p>
 <p>4 1600×361×18 1×</p>			
 <p>6a 1598×532,2×18 1×</p>		 <p>11 700,4×358×18 1×</p>	
 <p>6b 1598×532,2×18 1×</p>		 <p>12 514,3×358×18 1×</p>	
 <p>7 1600×165×18 1×</p>			

1

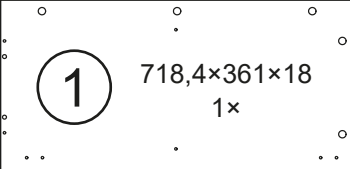
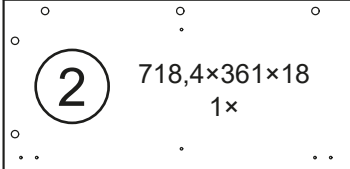
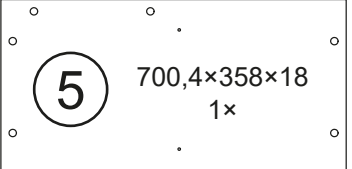
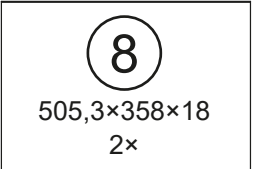
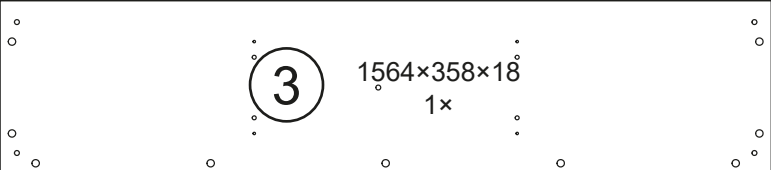
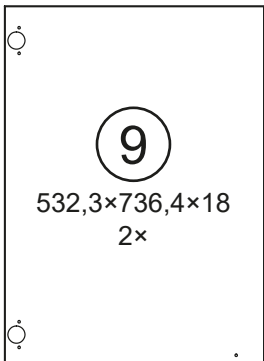
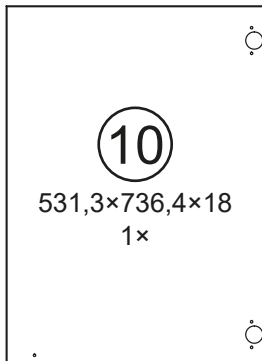
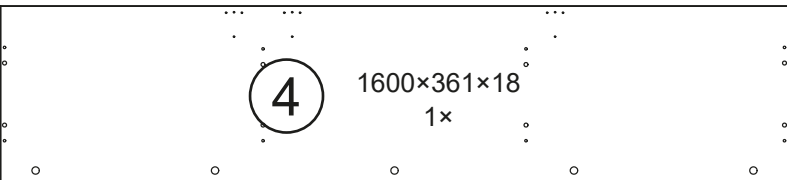
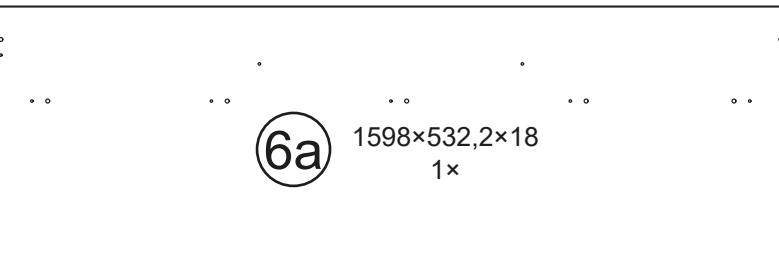
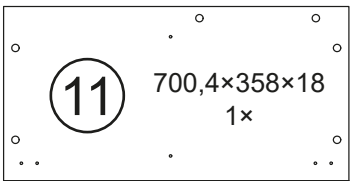
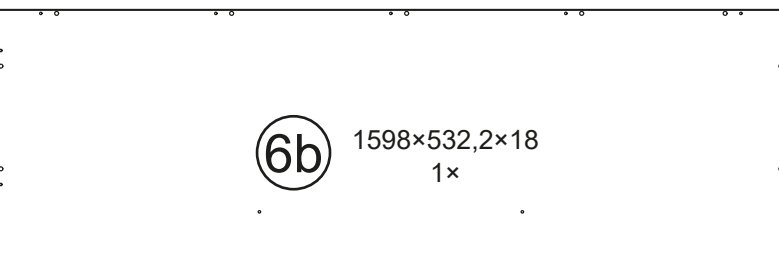
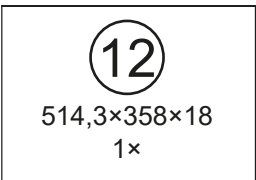
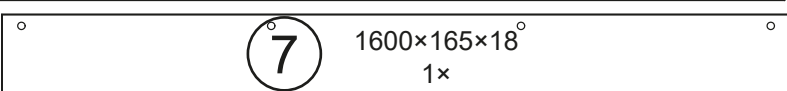
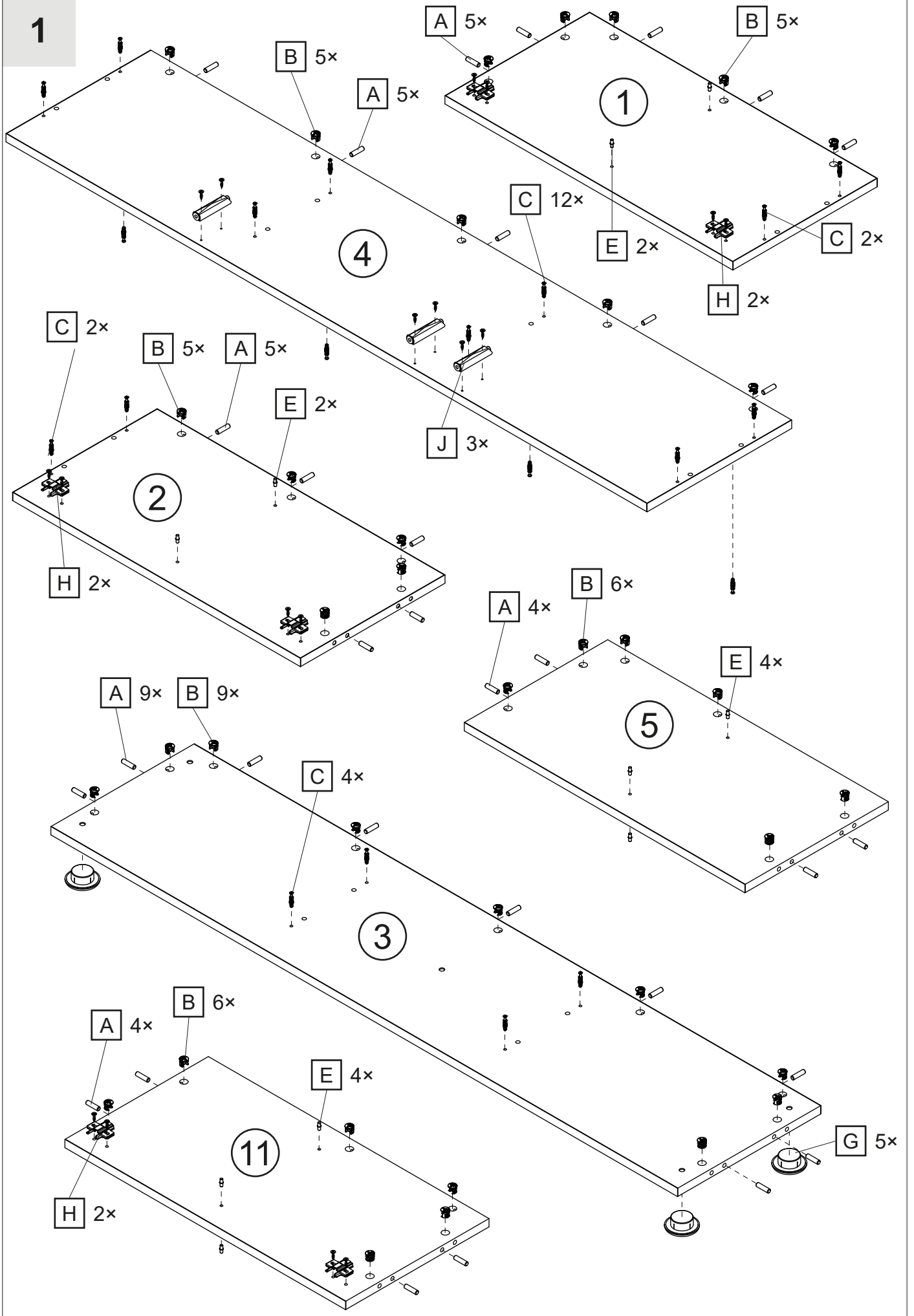
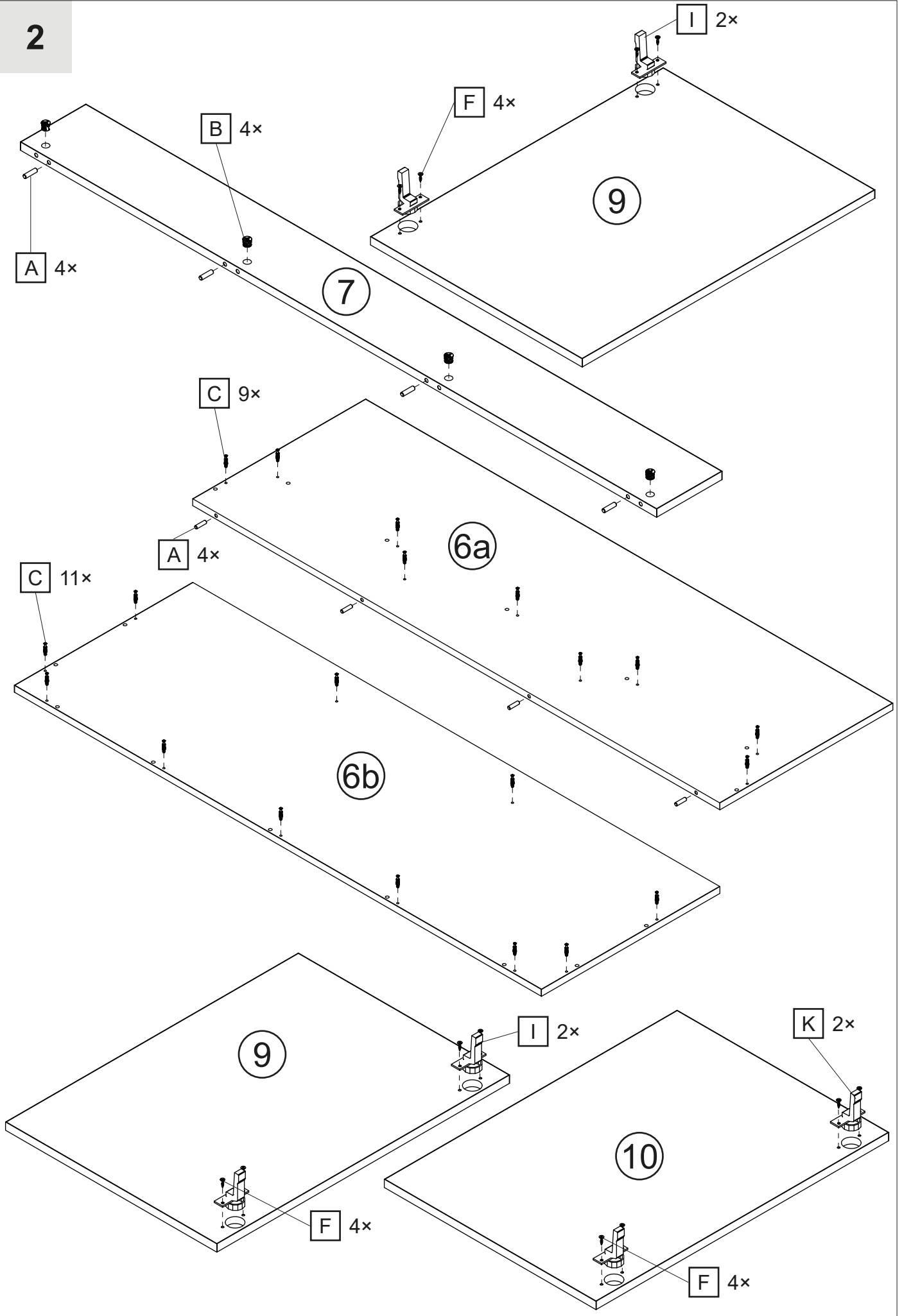

2



3

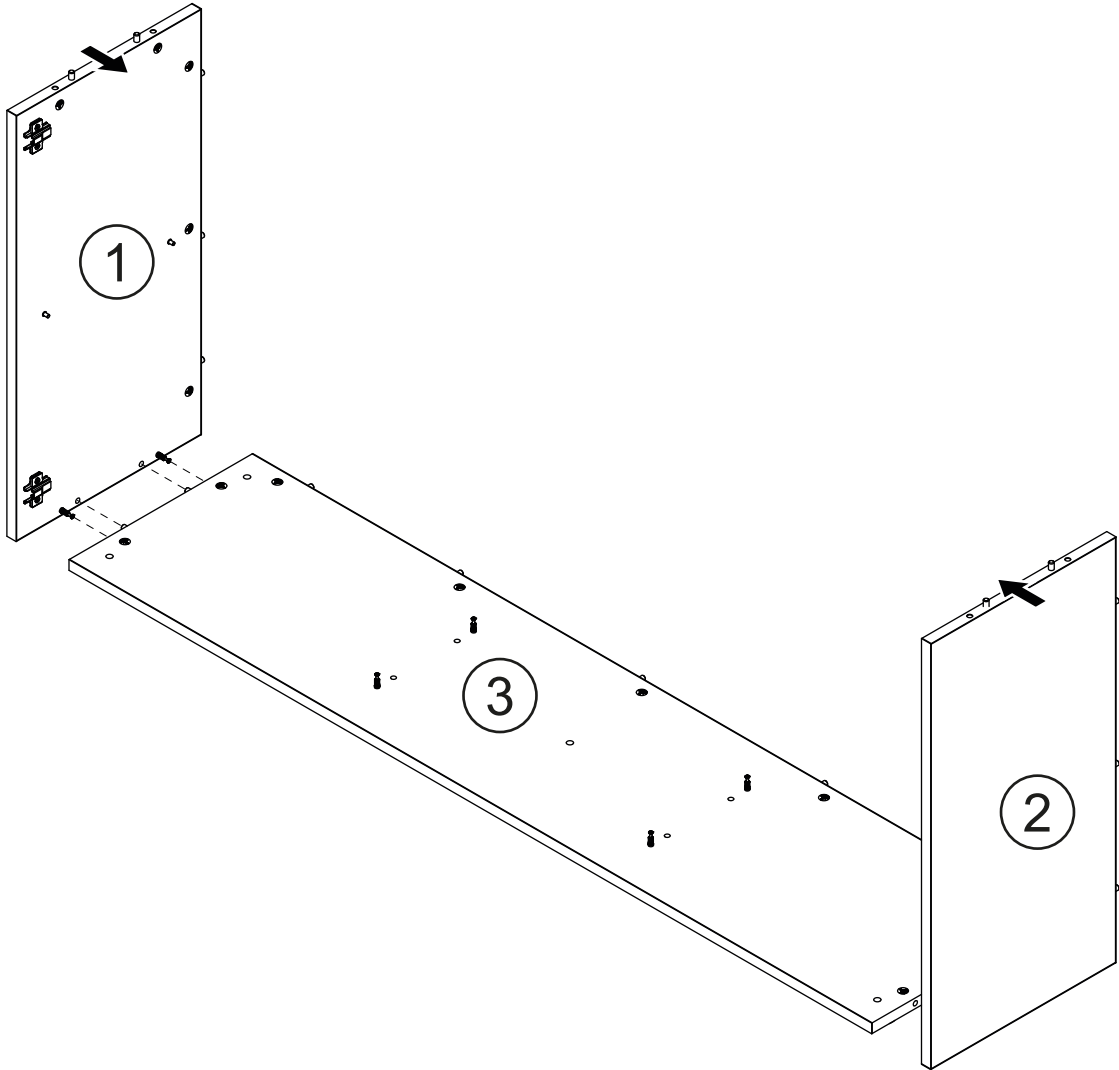

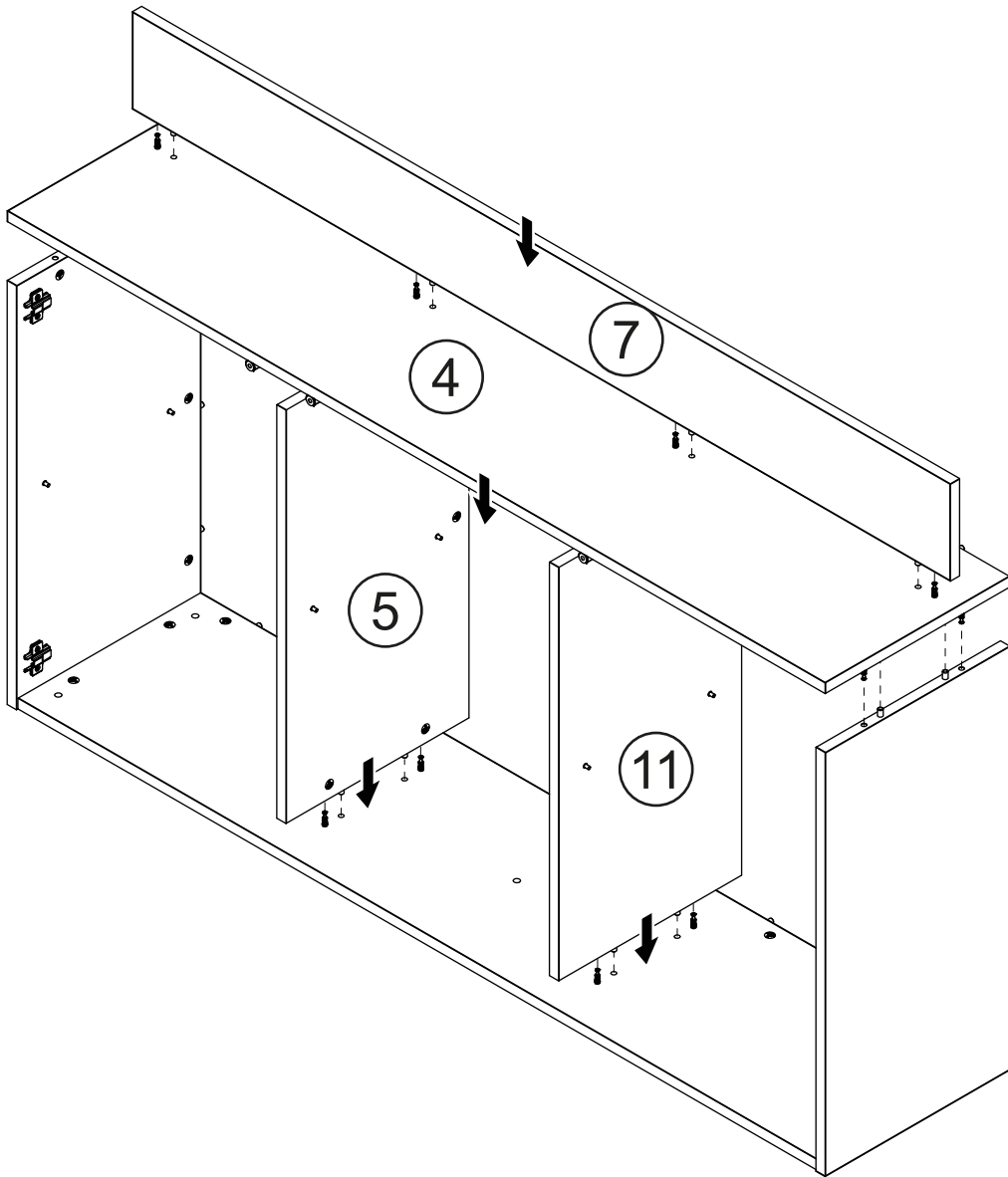

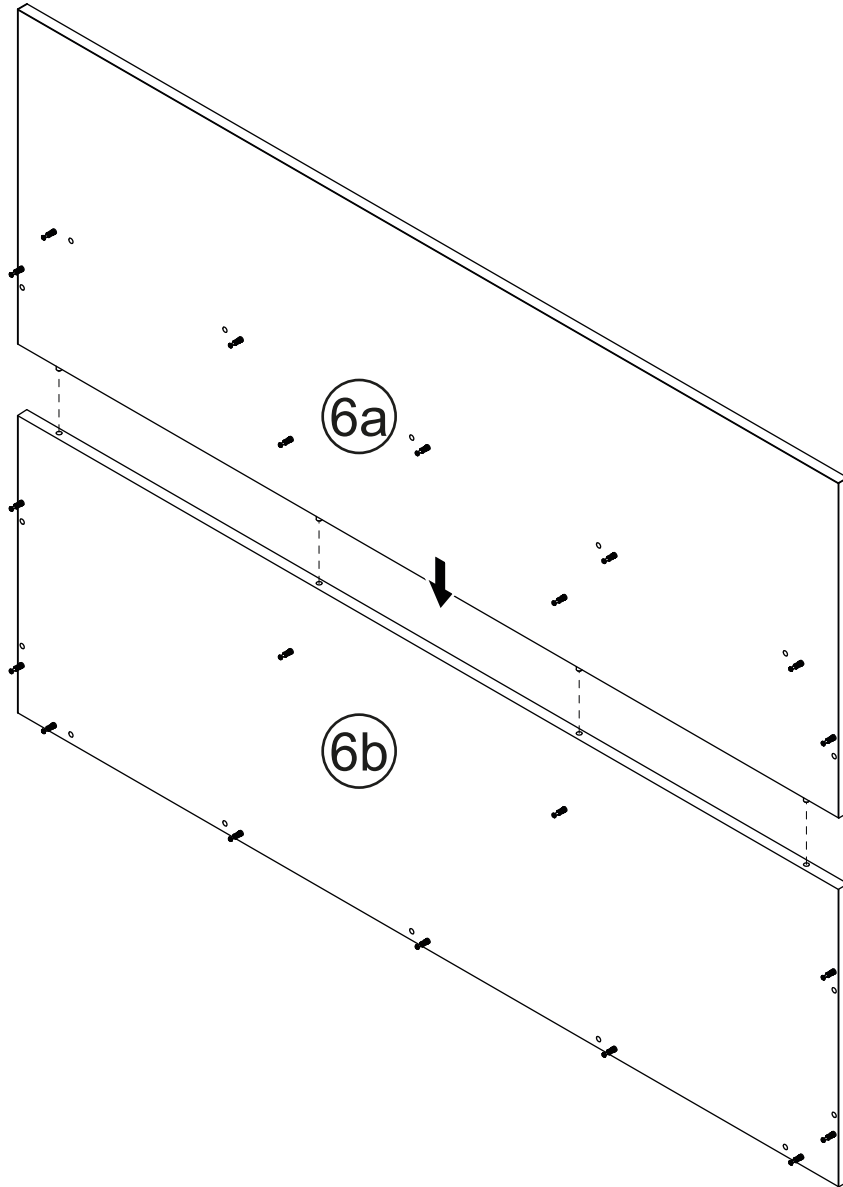

6

