

Ø8 × 35		Ø8 × 24			Ø3,5 × 35
A 24×	B 13×	C 13×	D 13×	E 2×	F 3×

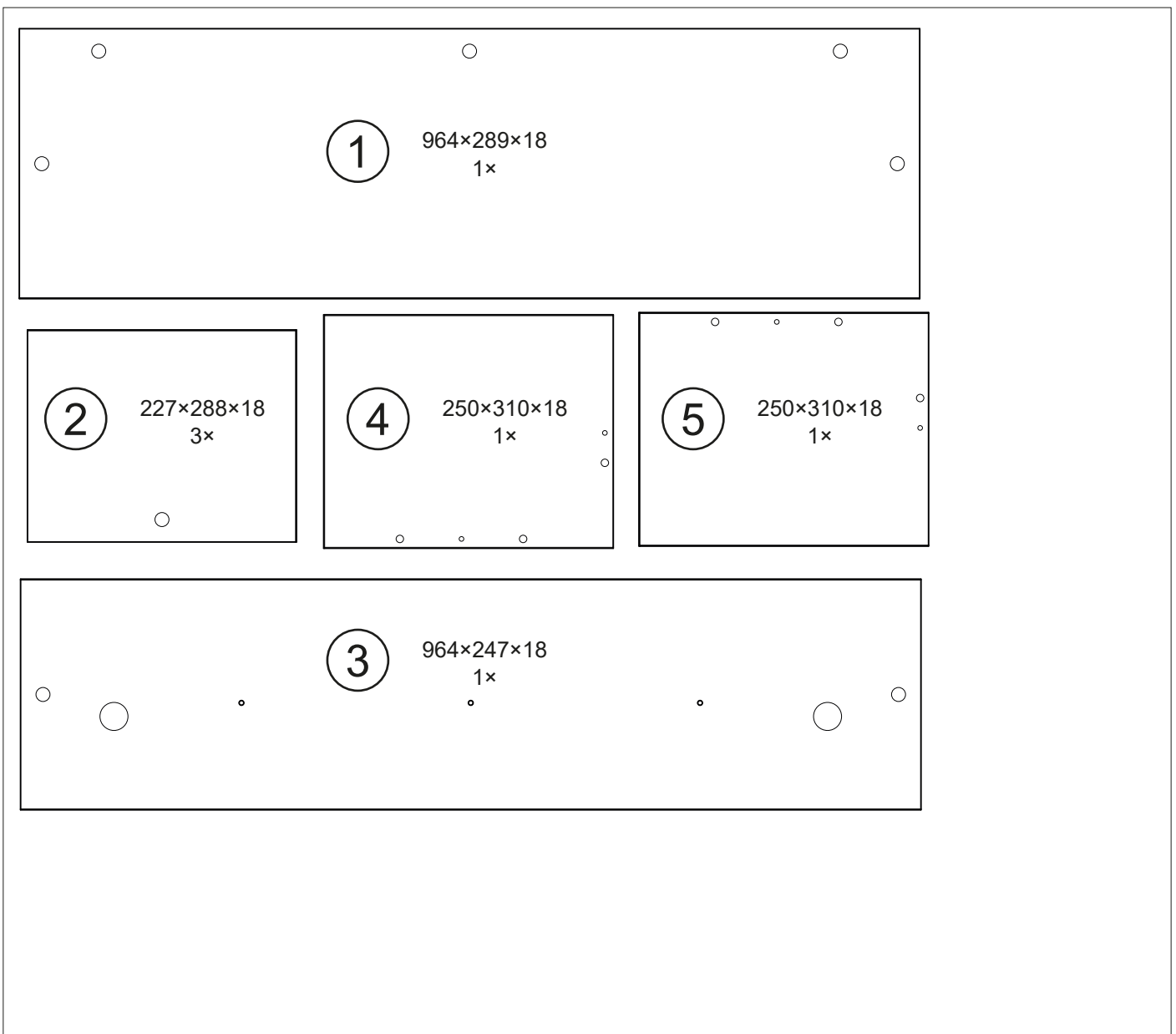

1

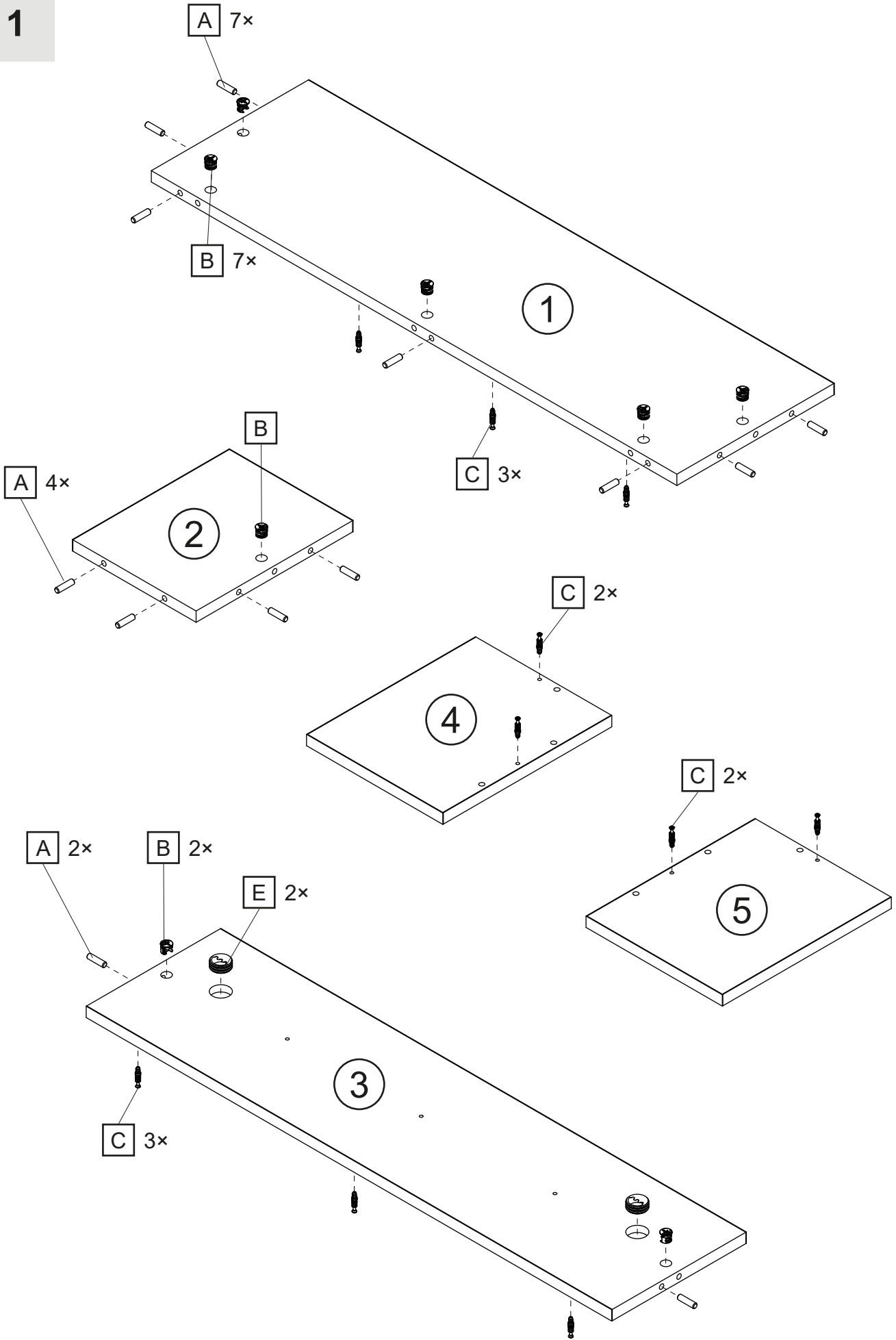
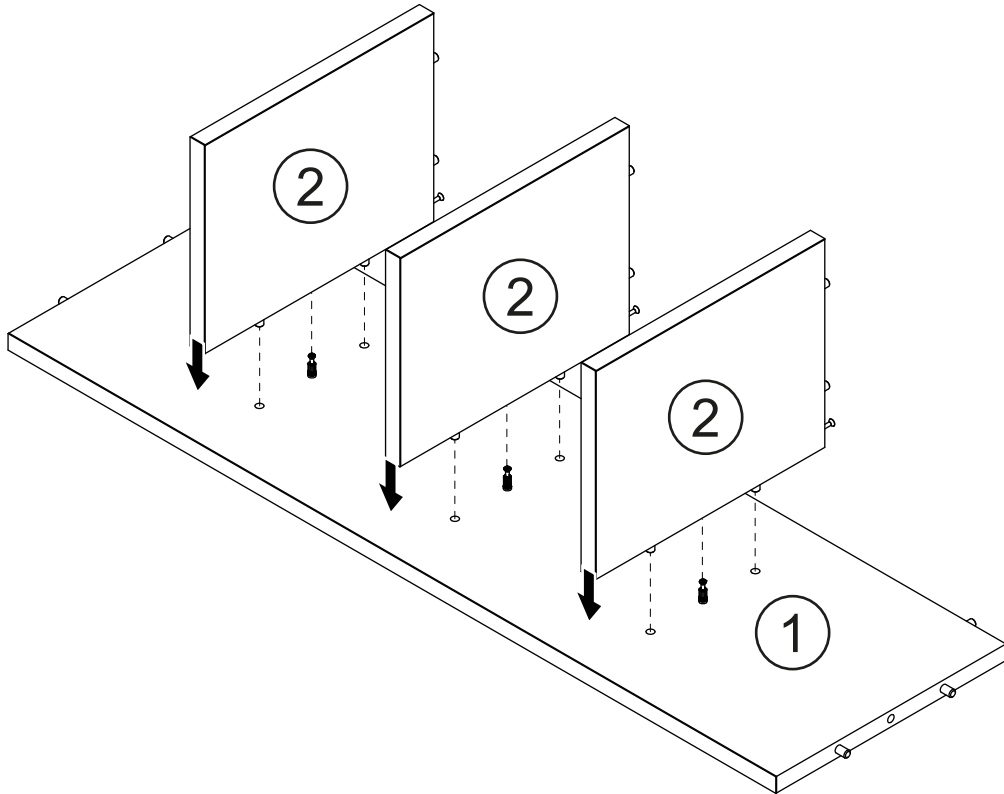

2



3

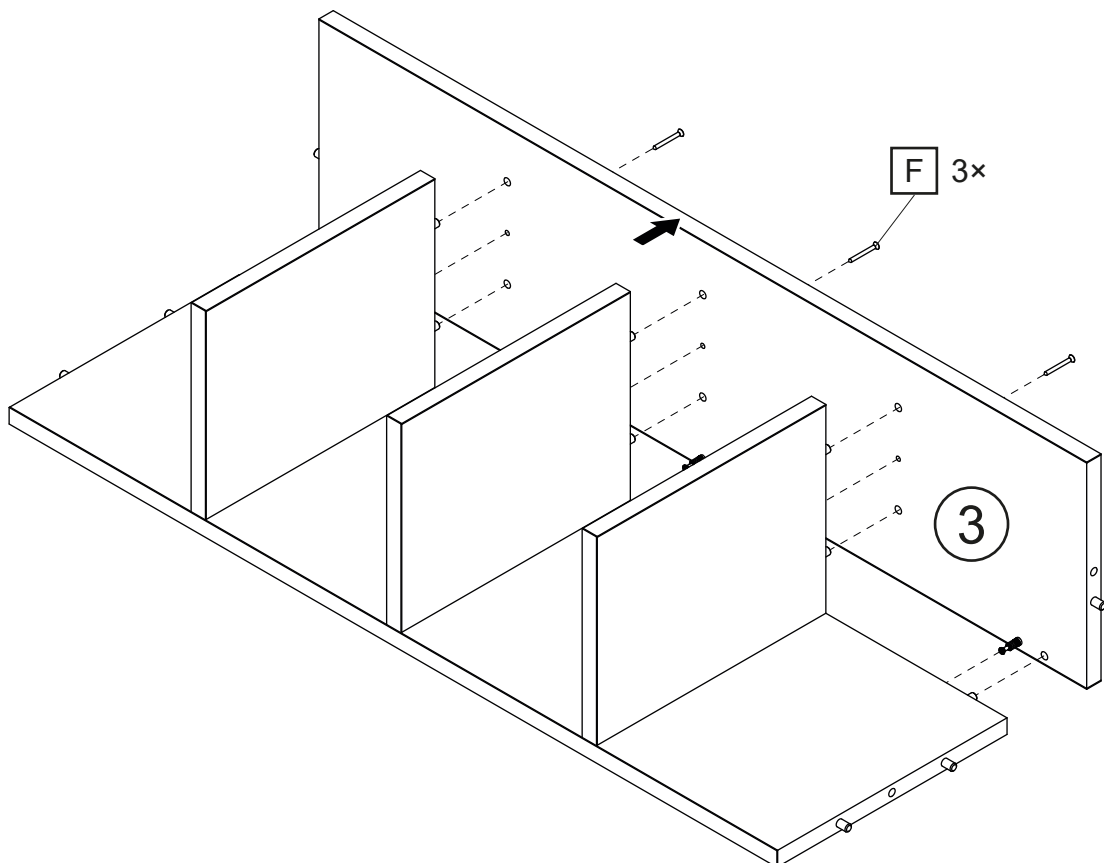

4

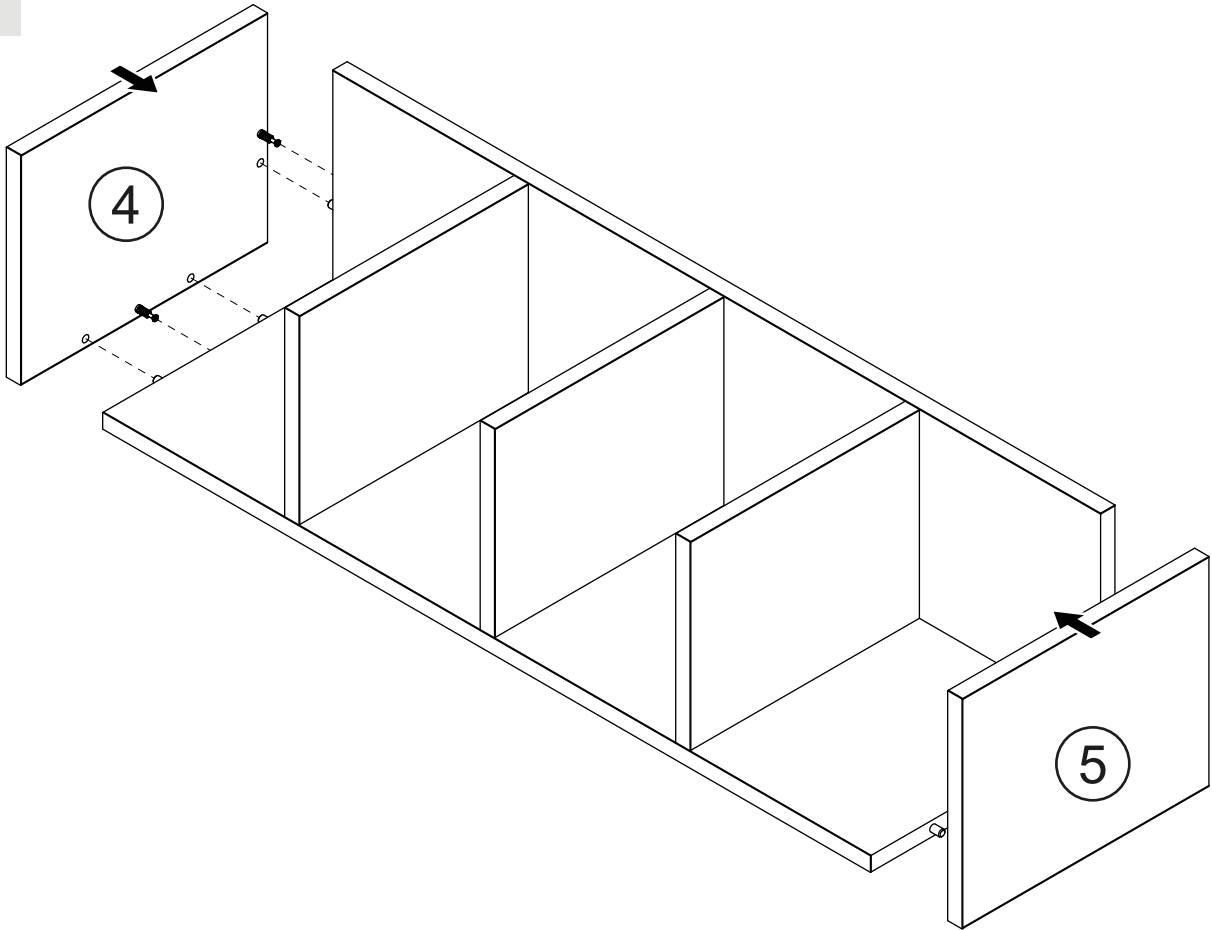

5

