



Ø8 × 35		Ø8 × 24				Ø3,5 × 16	
A 18×	B 8×	C 8×	D 8×	E 8×	F 4×	G 20×	H 2×
							
Ø8 × 27							
I 4×	J 4×	K 1×					



1

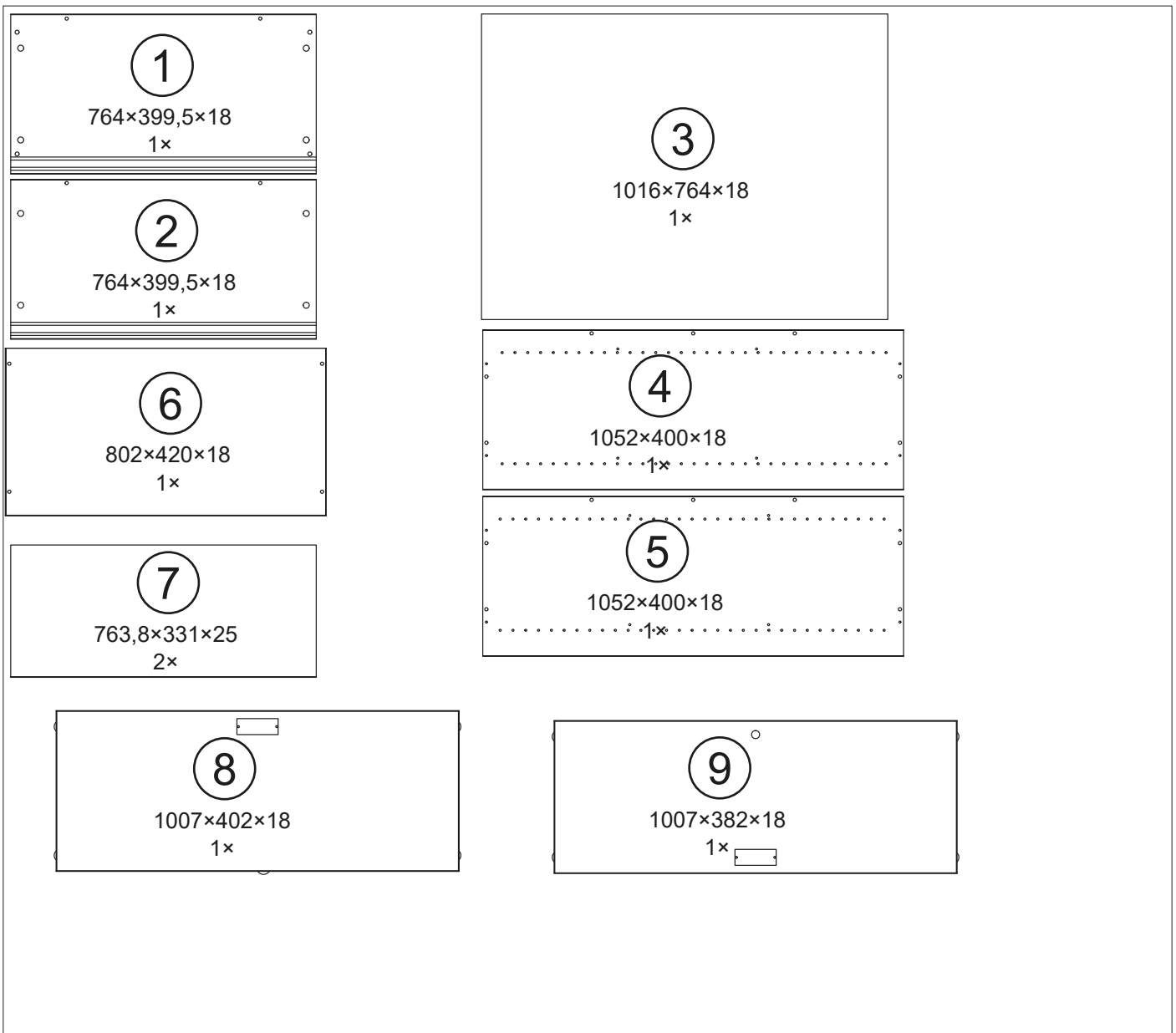
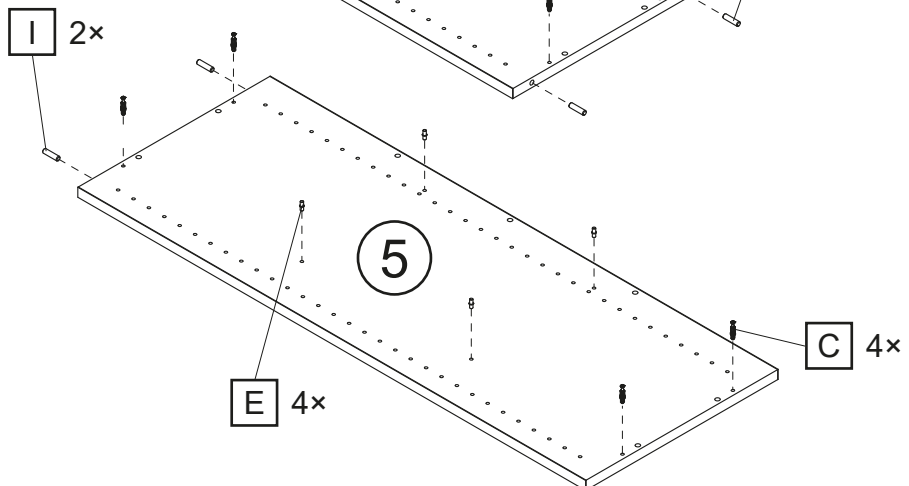
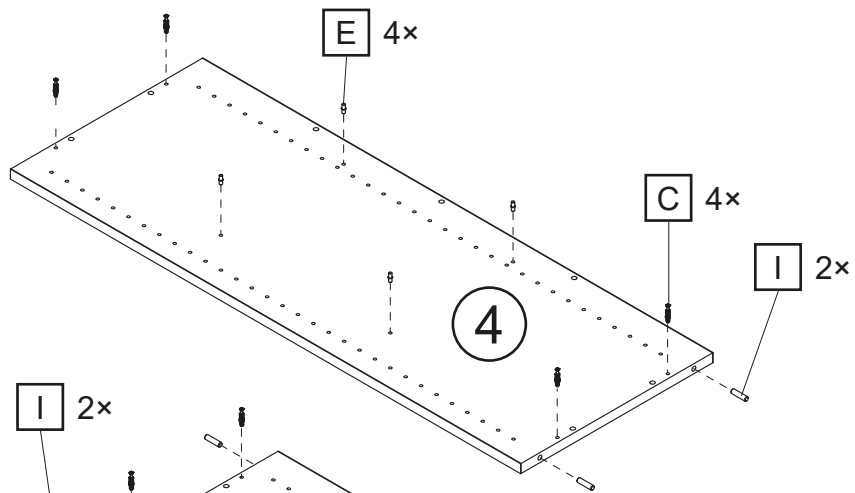
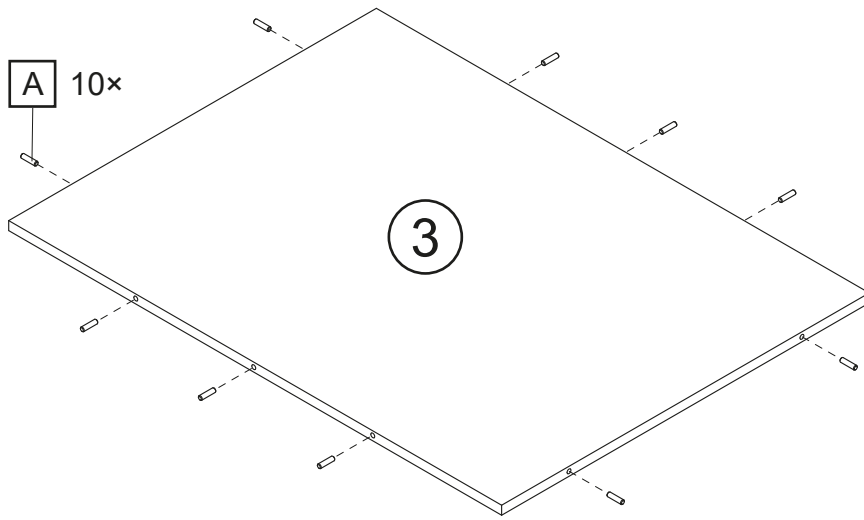
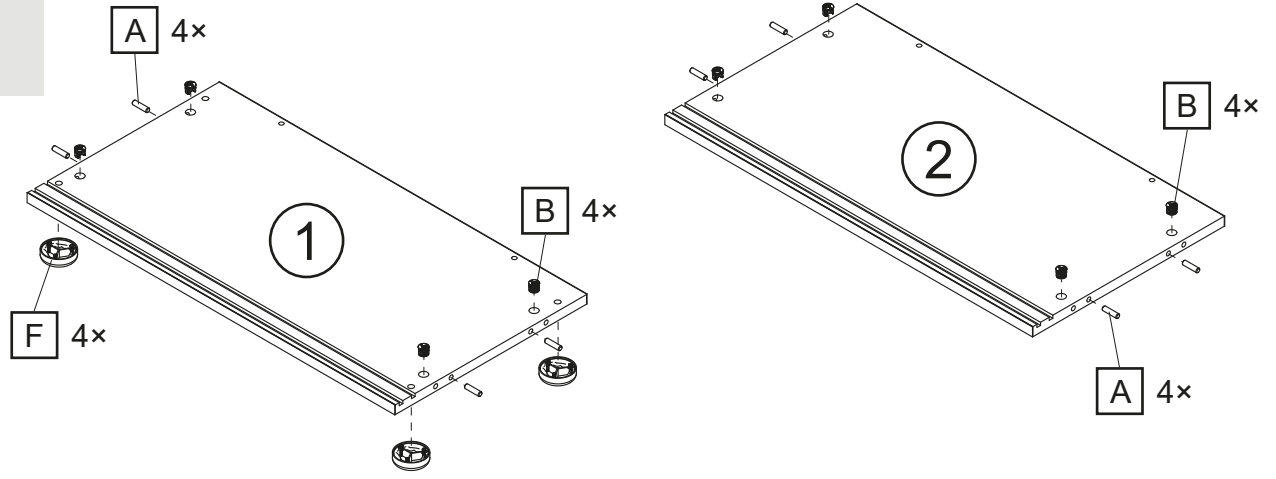
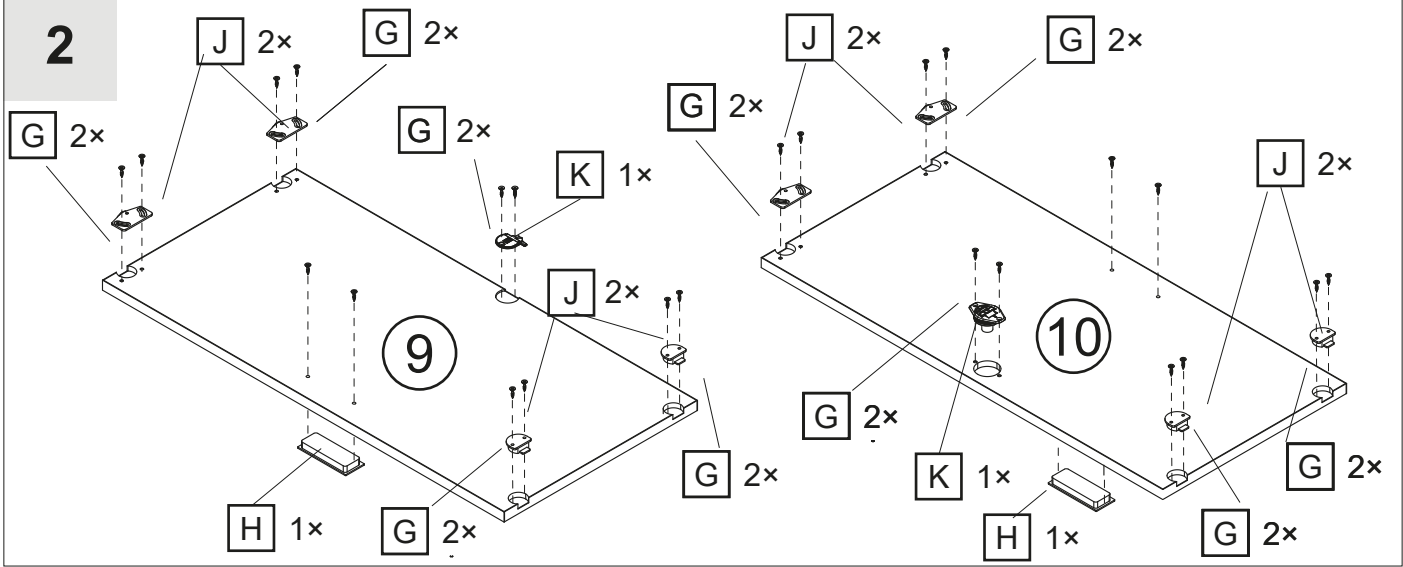

2



3

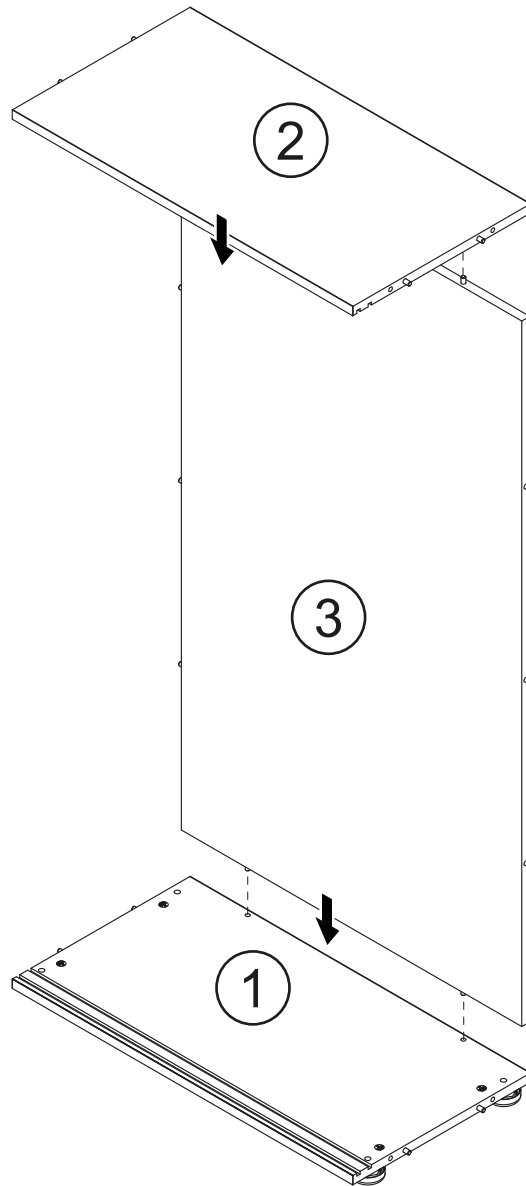

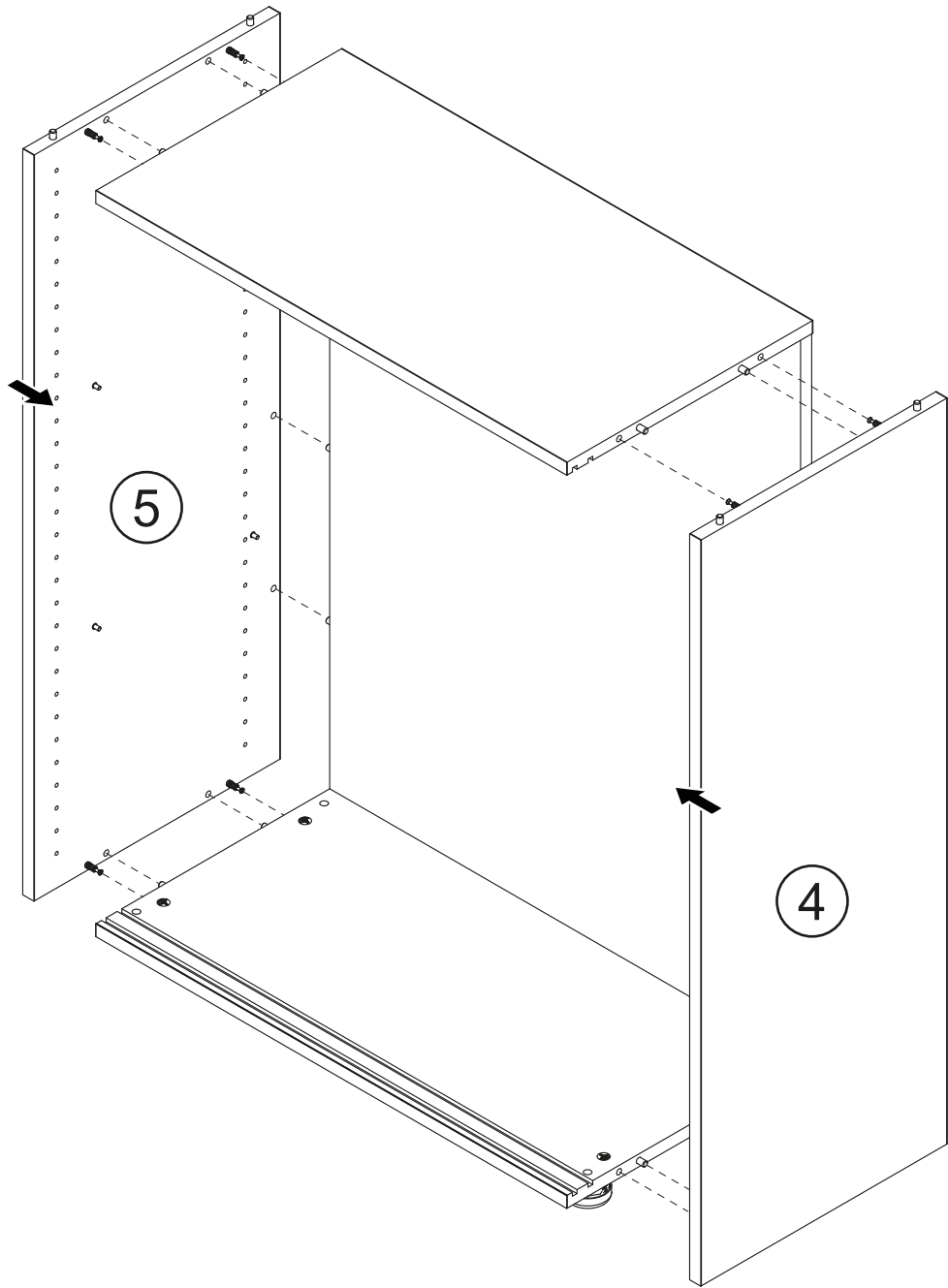

5

