



 Ø8 × 35					 Ø3,5 × 16	
A 2x	B 1x	C 1x	D 1x	E 4x	F 8x	G 1x





4

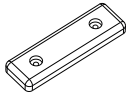

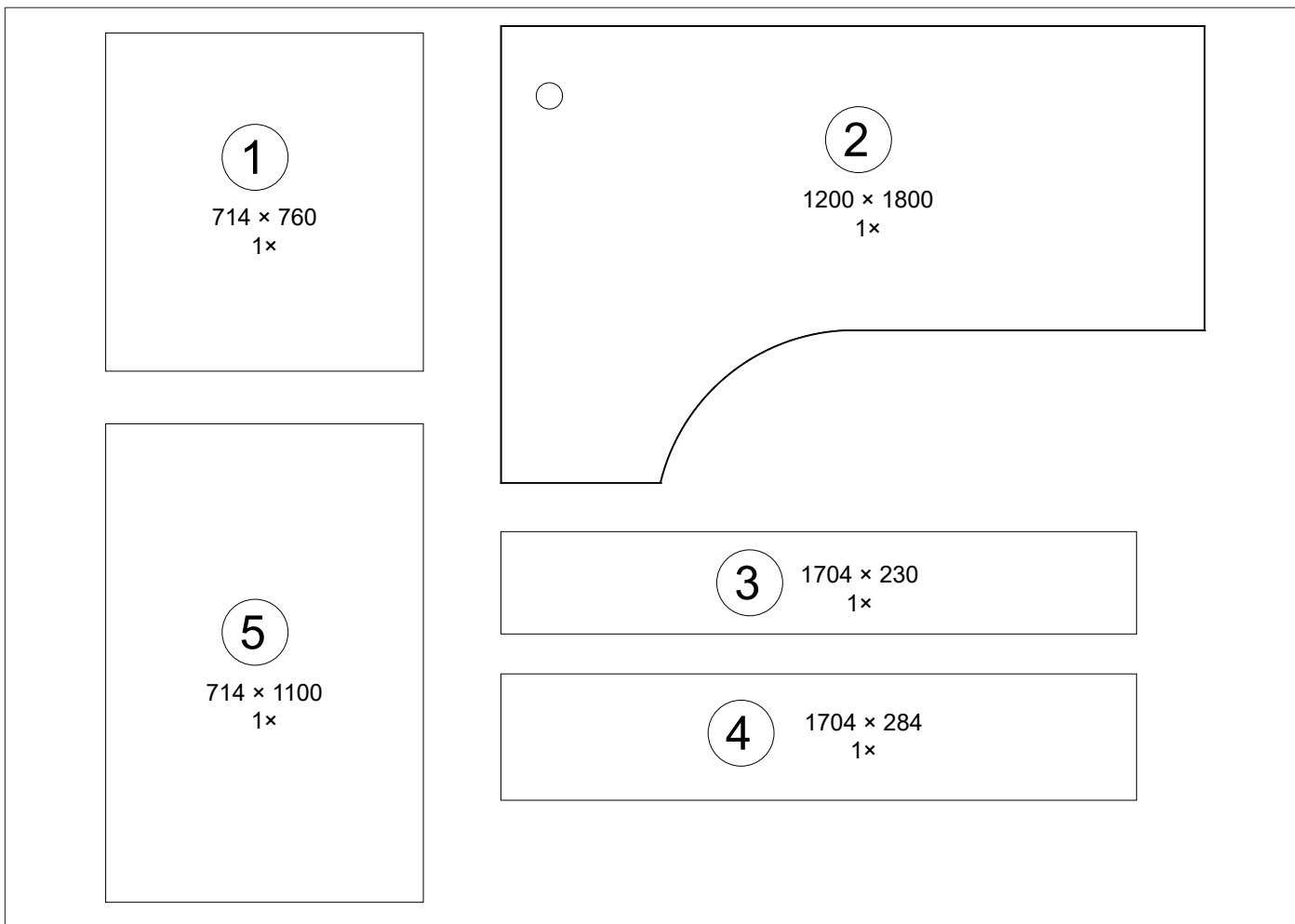
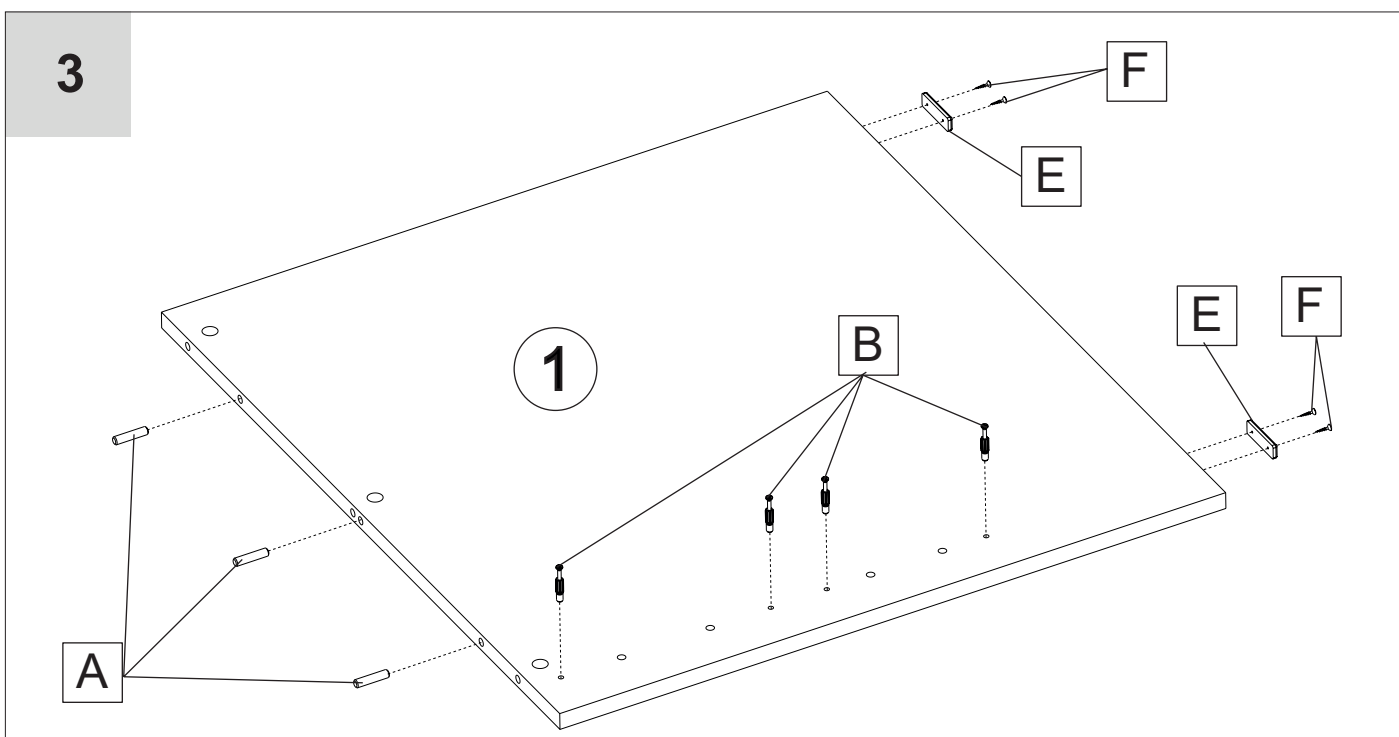
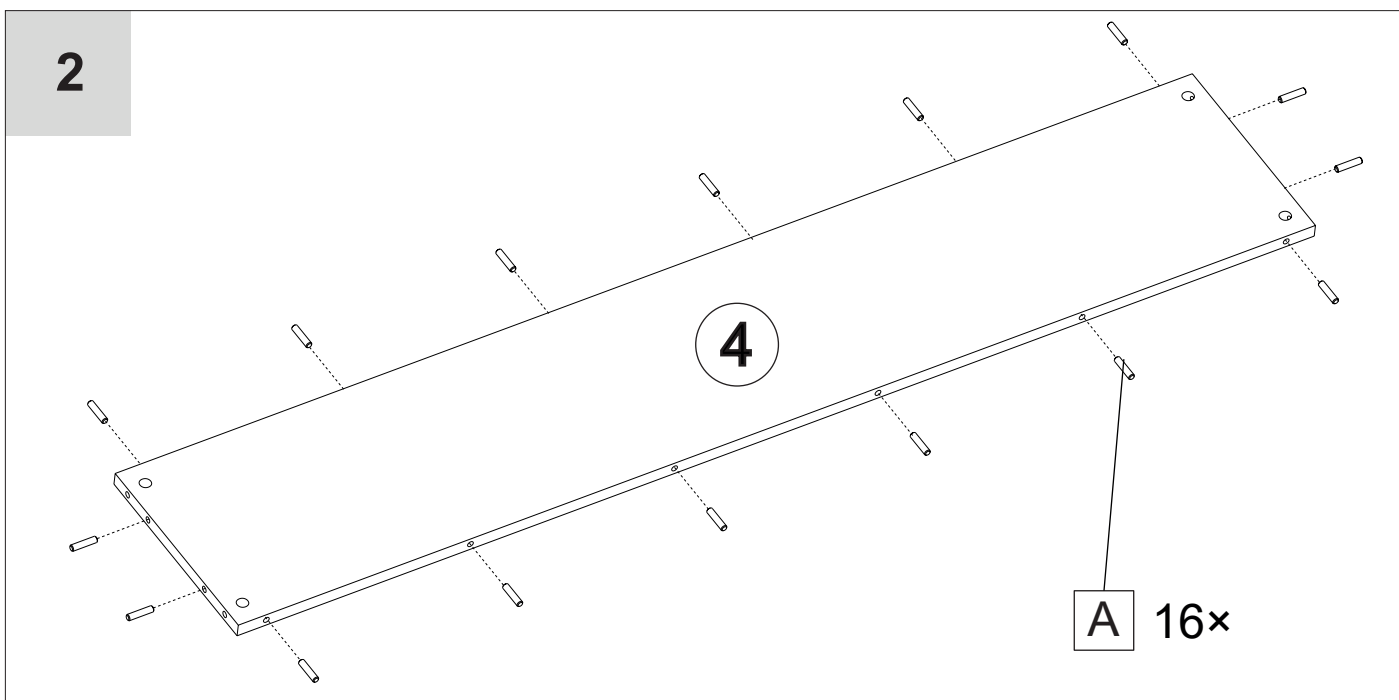
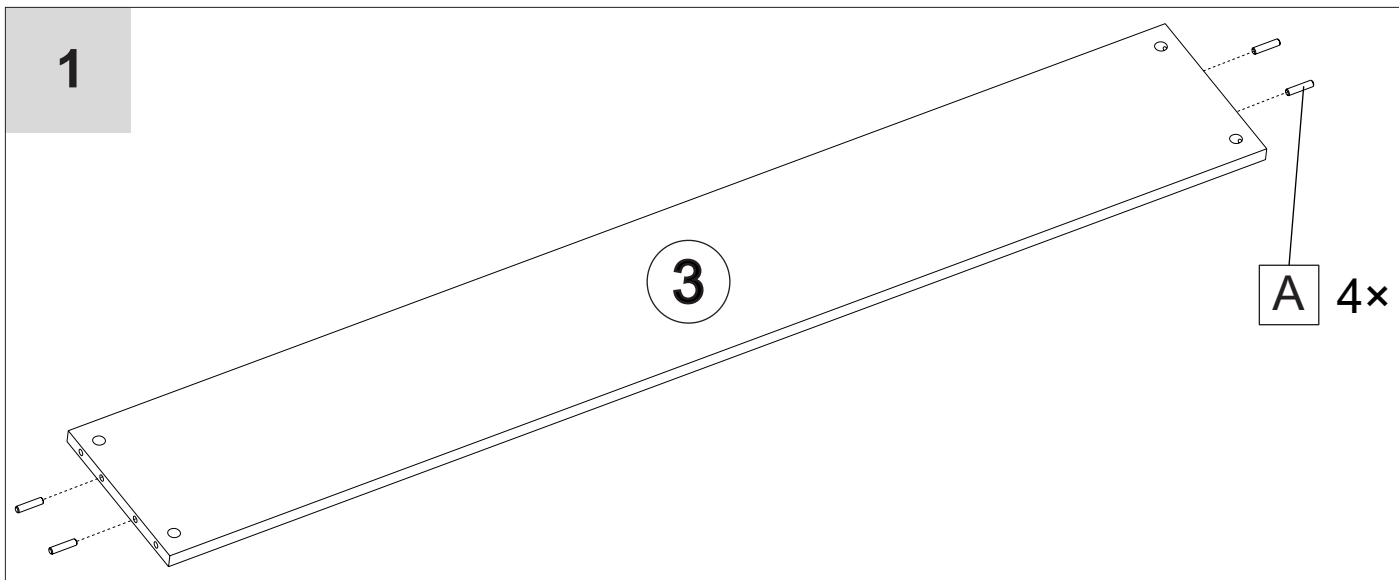
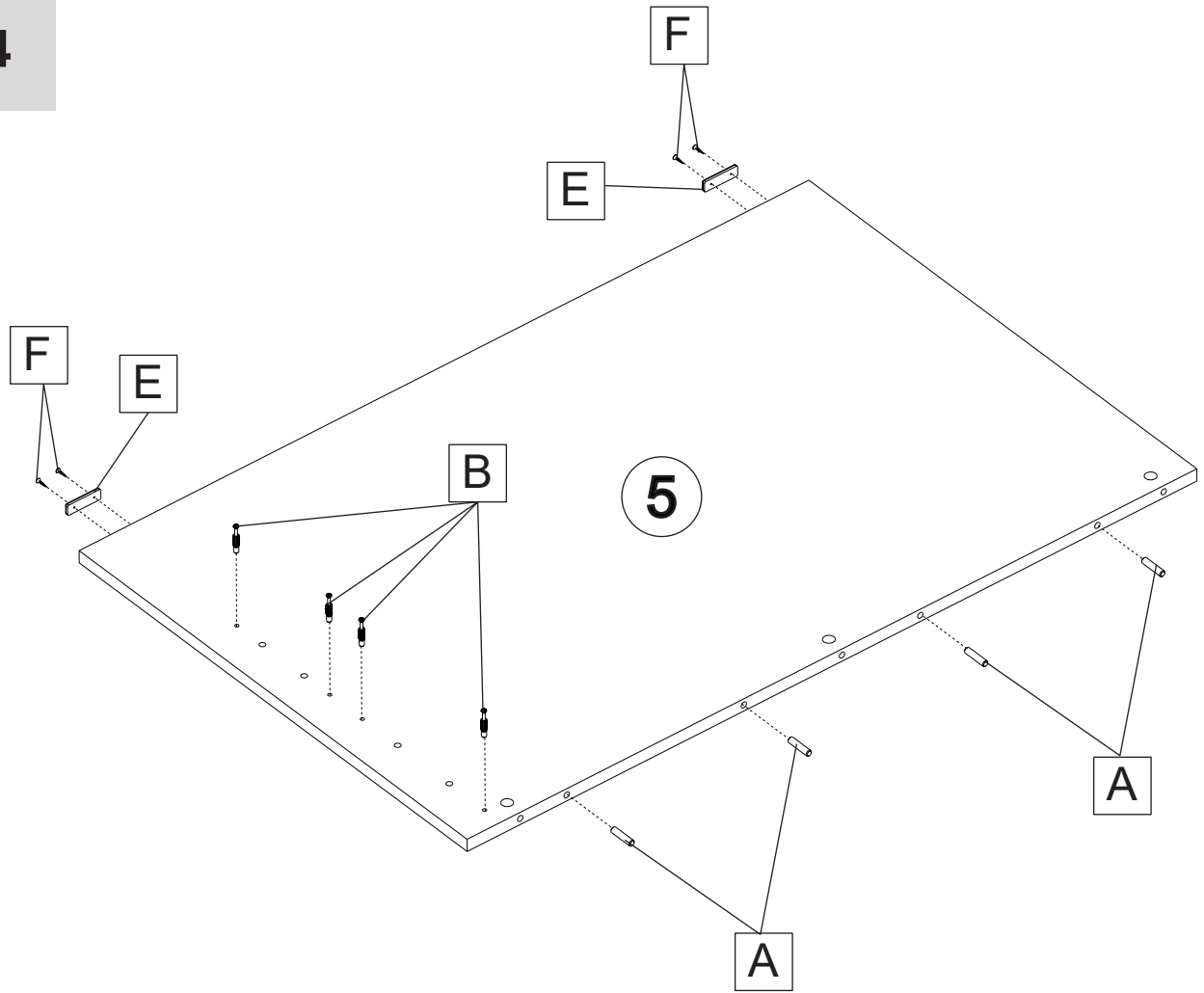
5

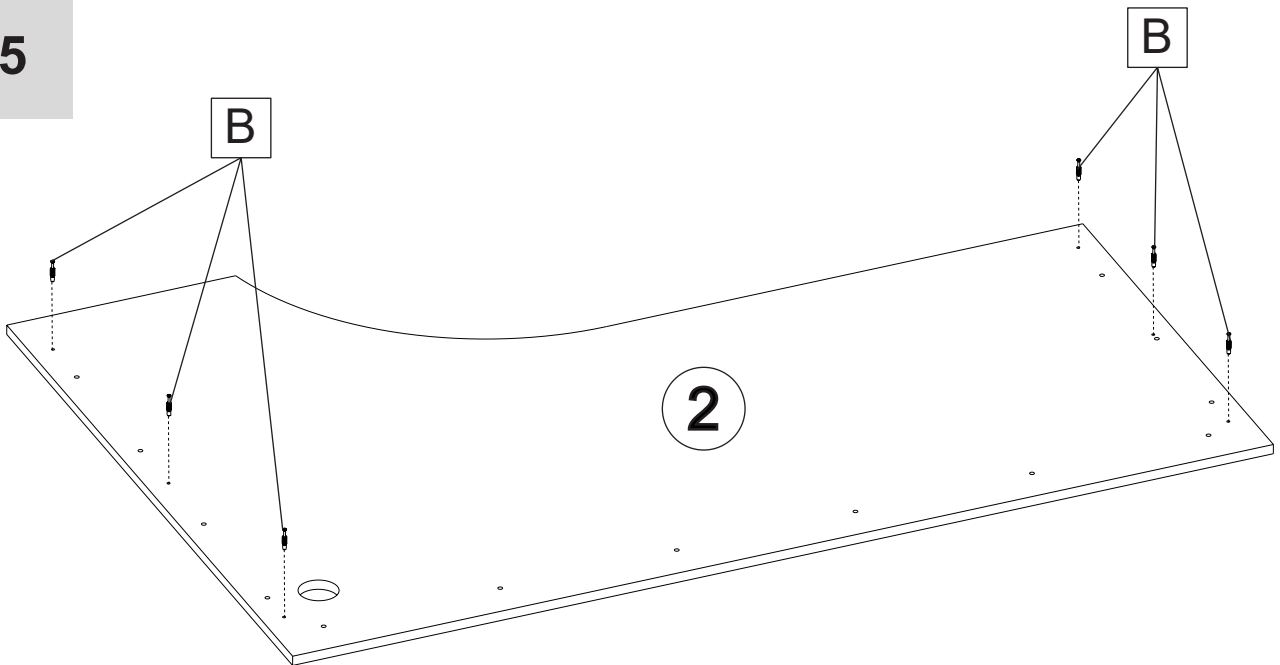

6

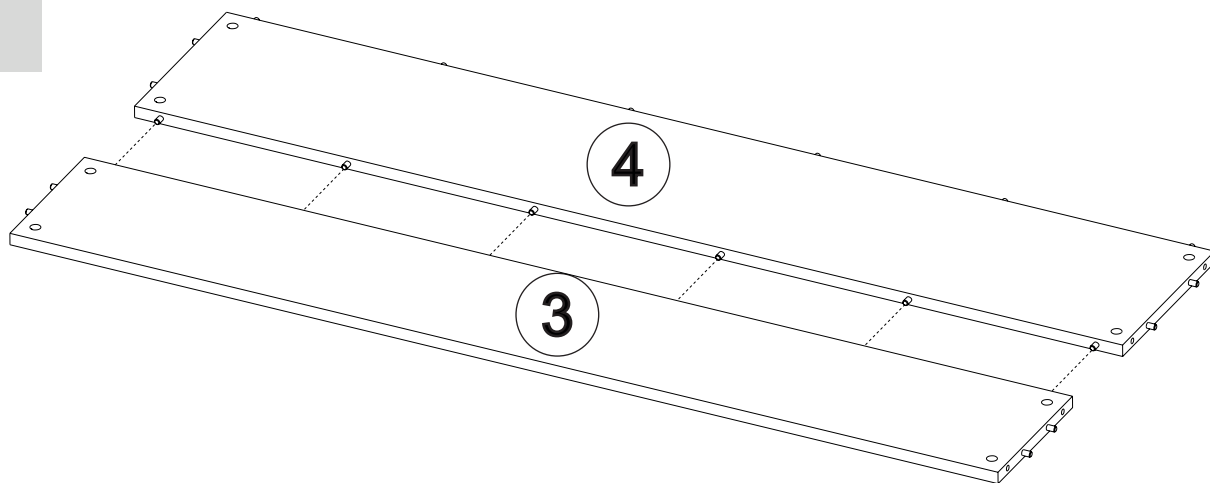

7

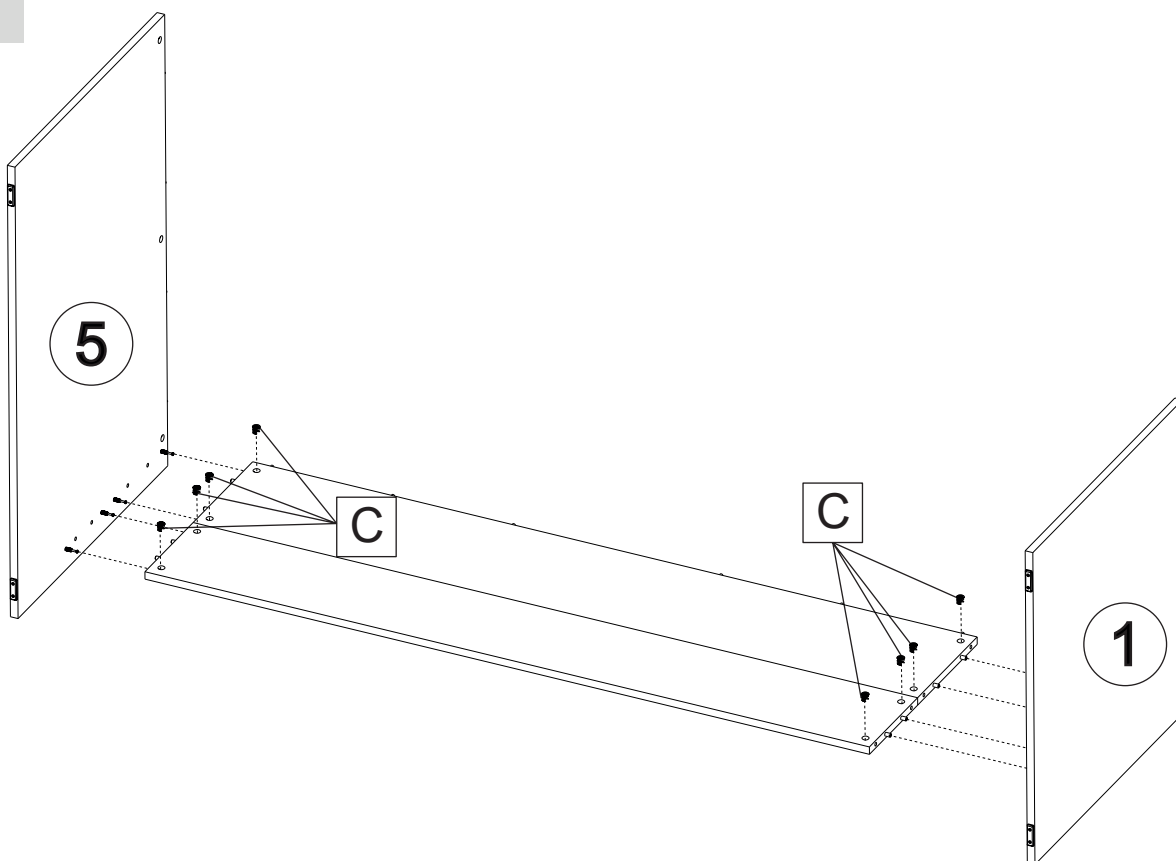

8

