

NÁVOD NA MONTÁŽ PLOTOVÉHO PANELU S LAMELAMI „Z“

B

U profil

**F**

krycia lišta

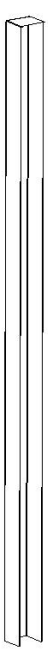
**C**

-vrchný profil

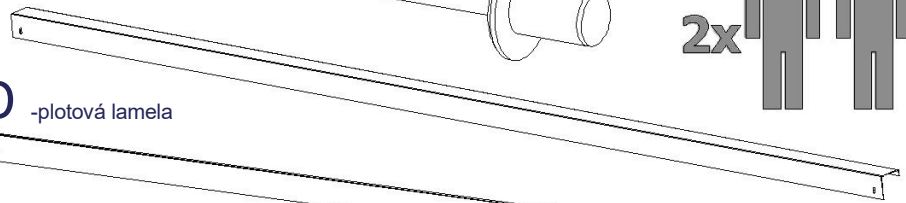

2x

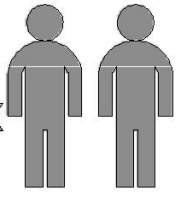
**D**

-plotová lamela

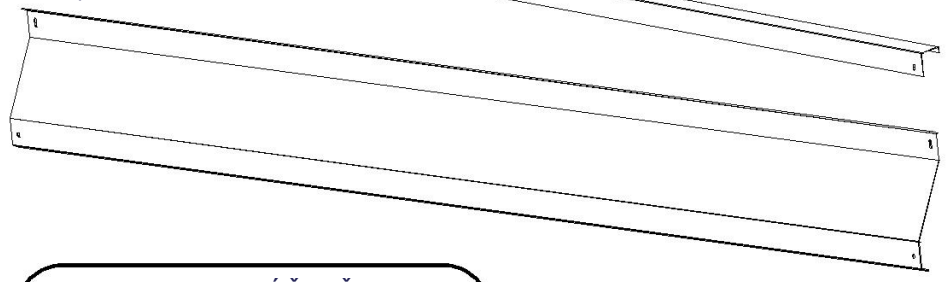
NIE JE SÚČASŤOU
BALENIASAMOVRTNÁ
SKRUTKA
TEX 4,2 x 16

PODLOŽKA



VRUT

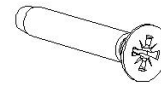

HMOŽDINKA

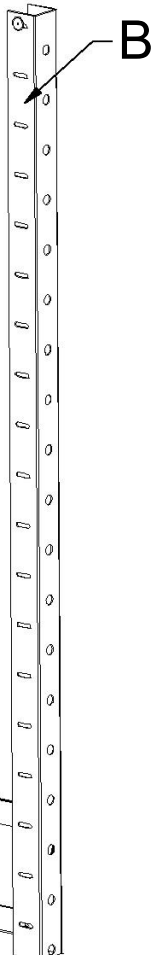
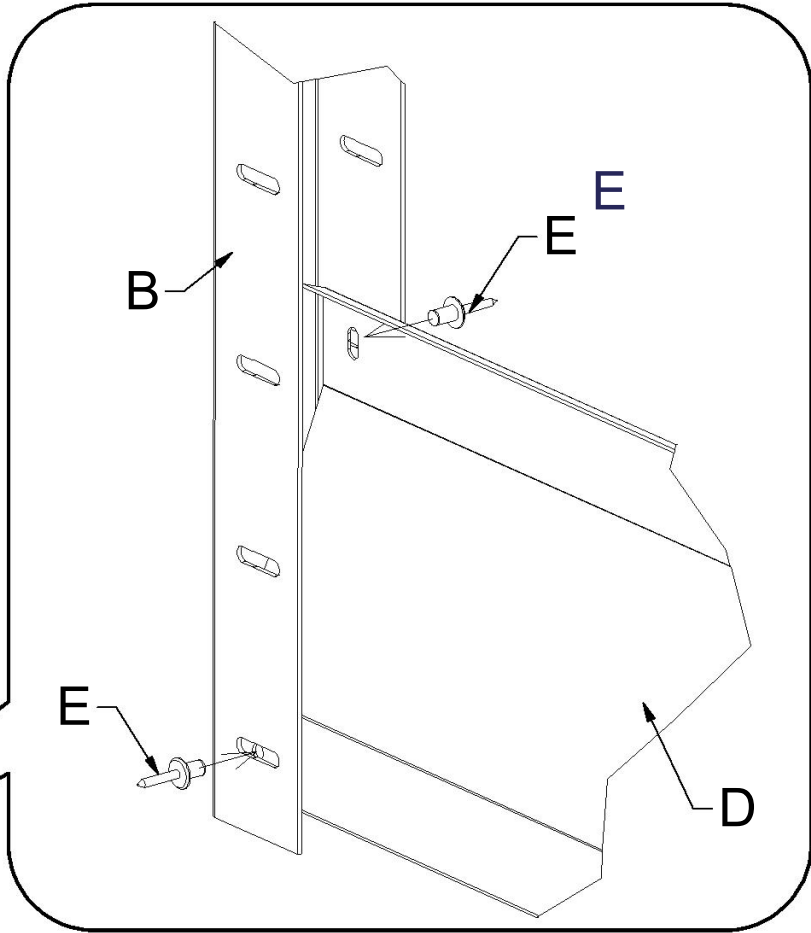
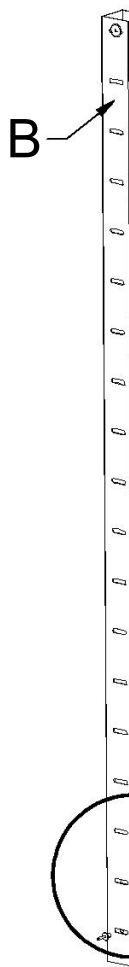
**1**

1/5

POHĽAD Z ČELNEJ STRANY

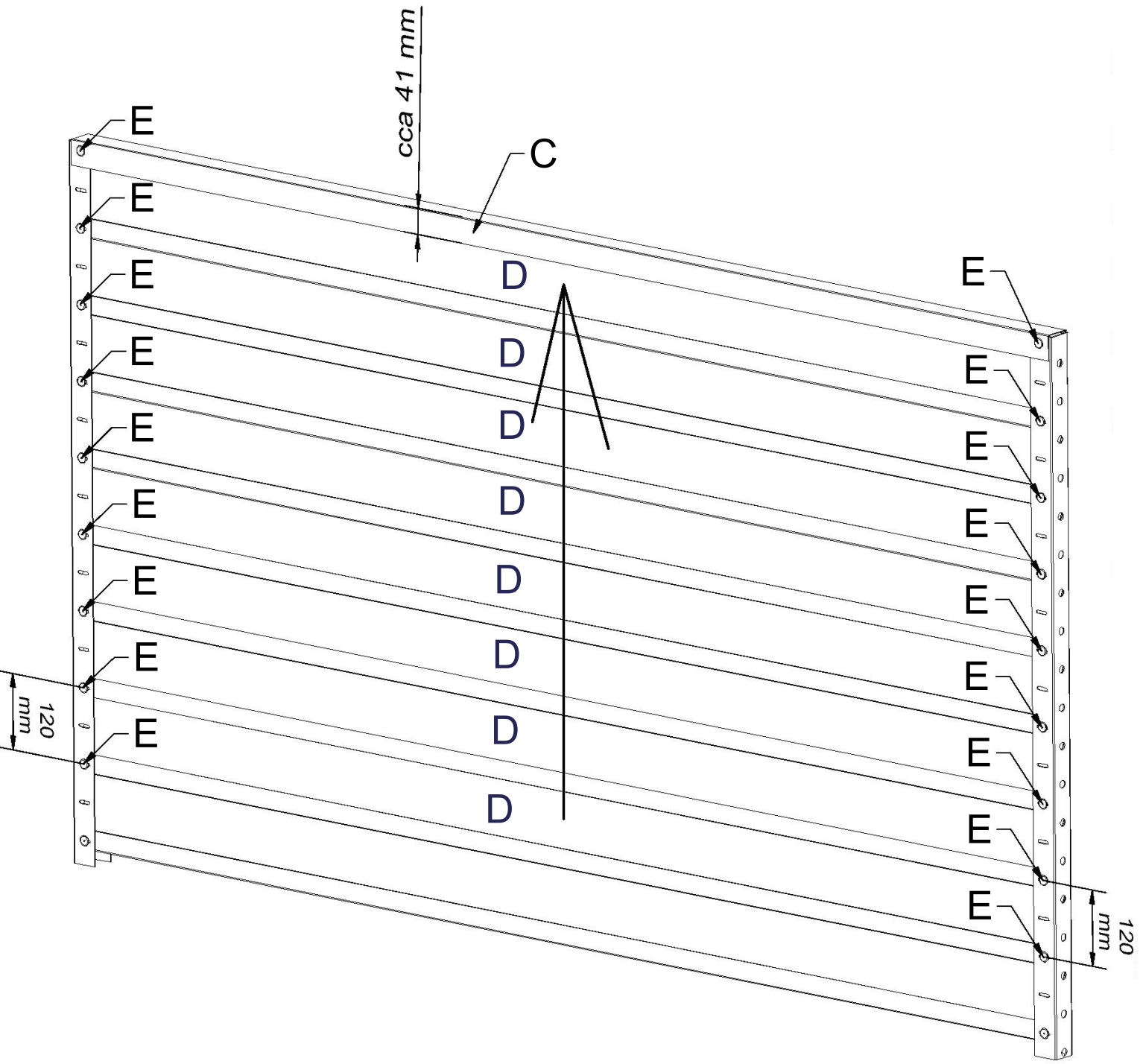

POHĽAD Z ČELNEJ STRANY

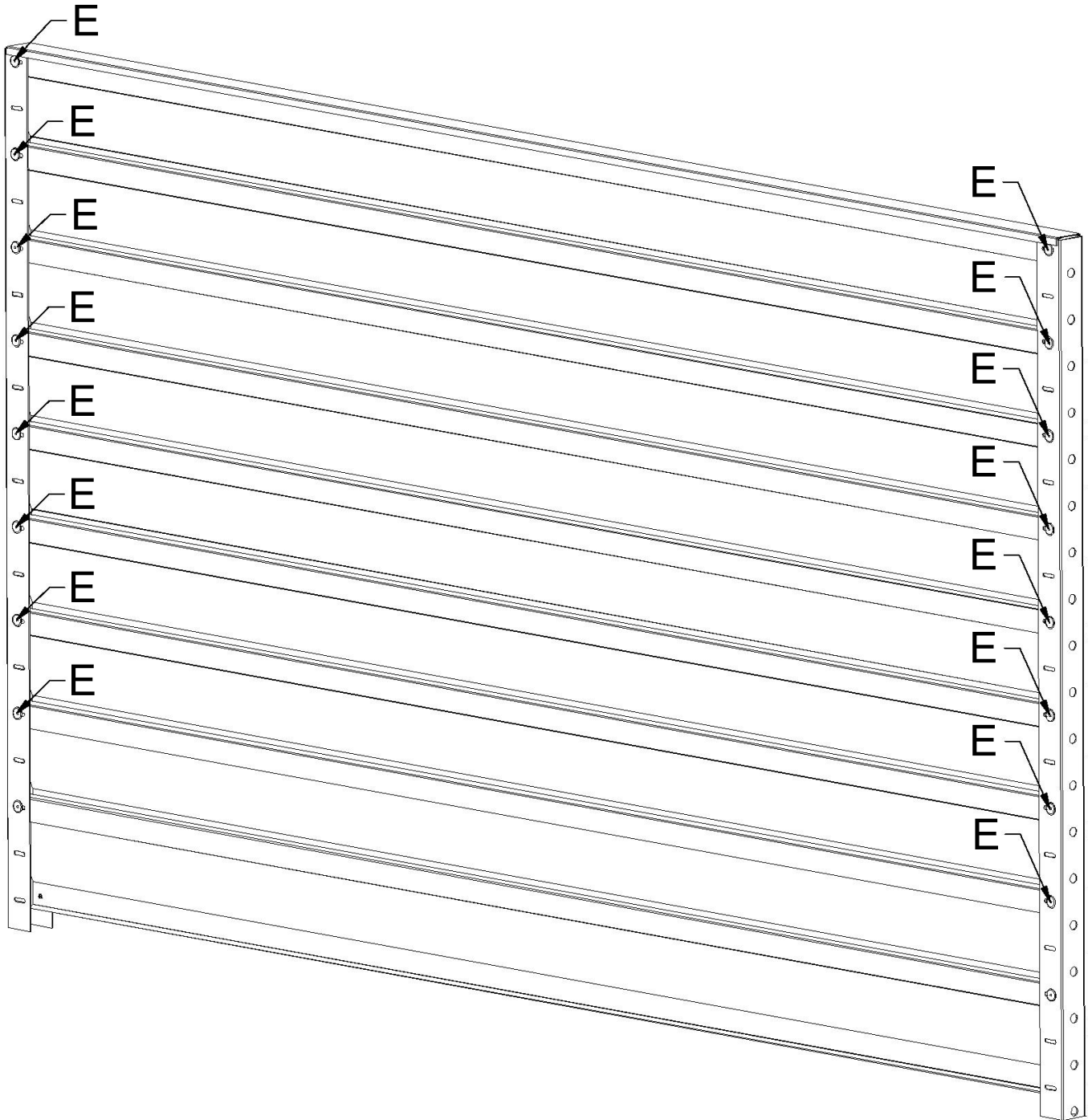

POHĽAD Z PROTIĽAHLEJ STRANY

4

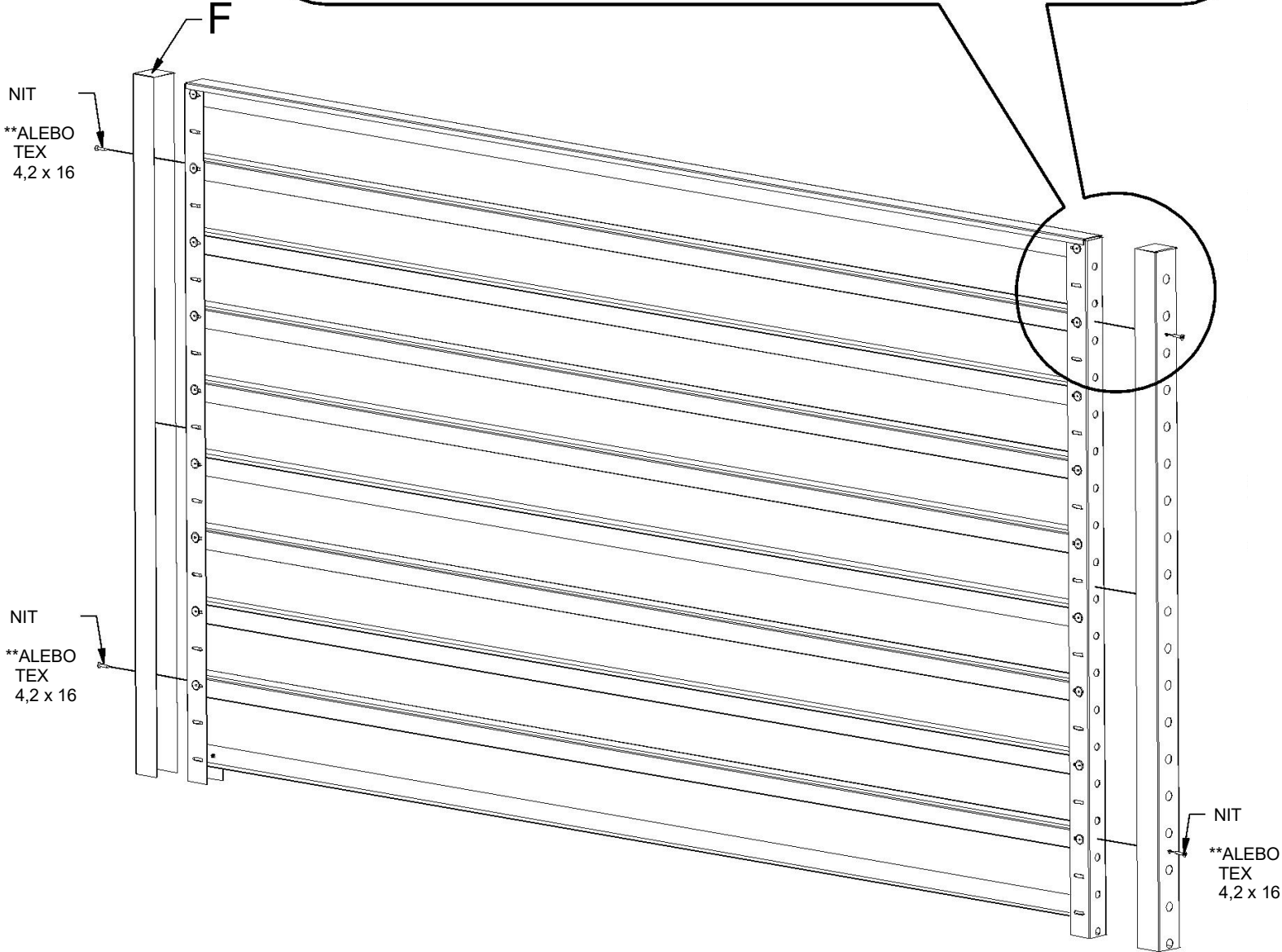
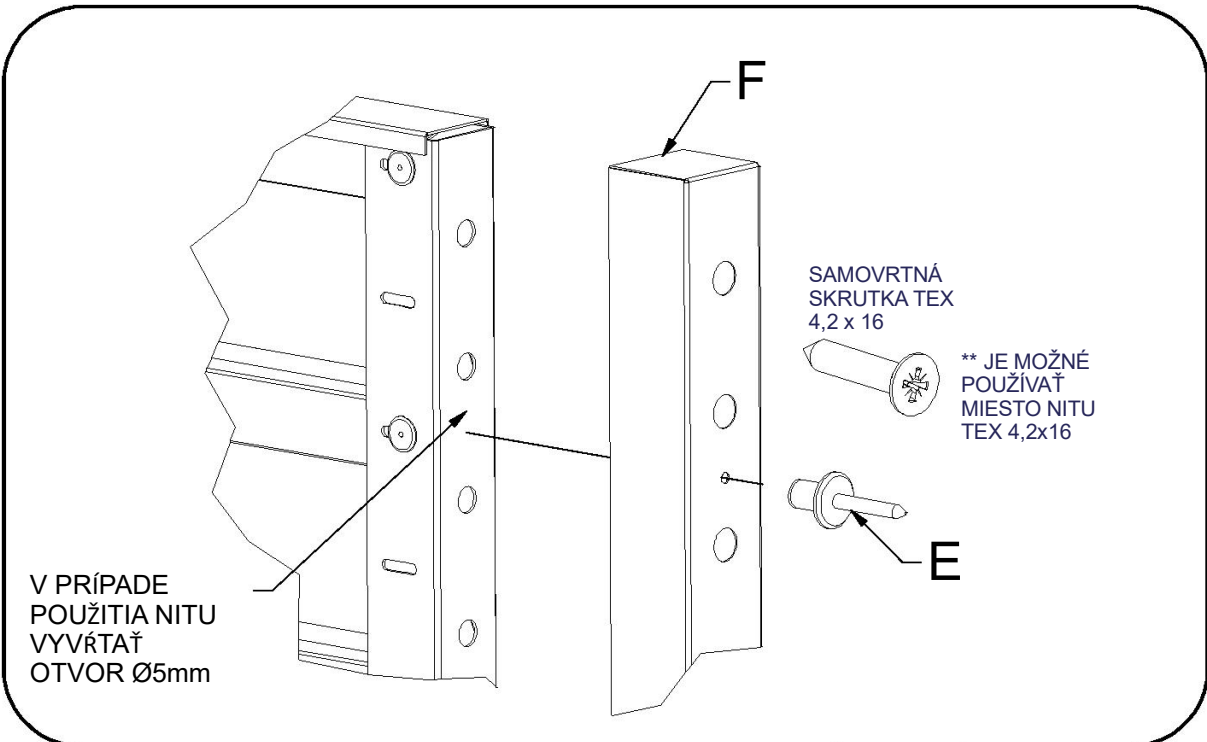

POHĽAD Z ČELNEJ STRANY

5

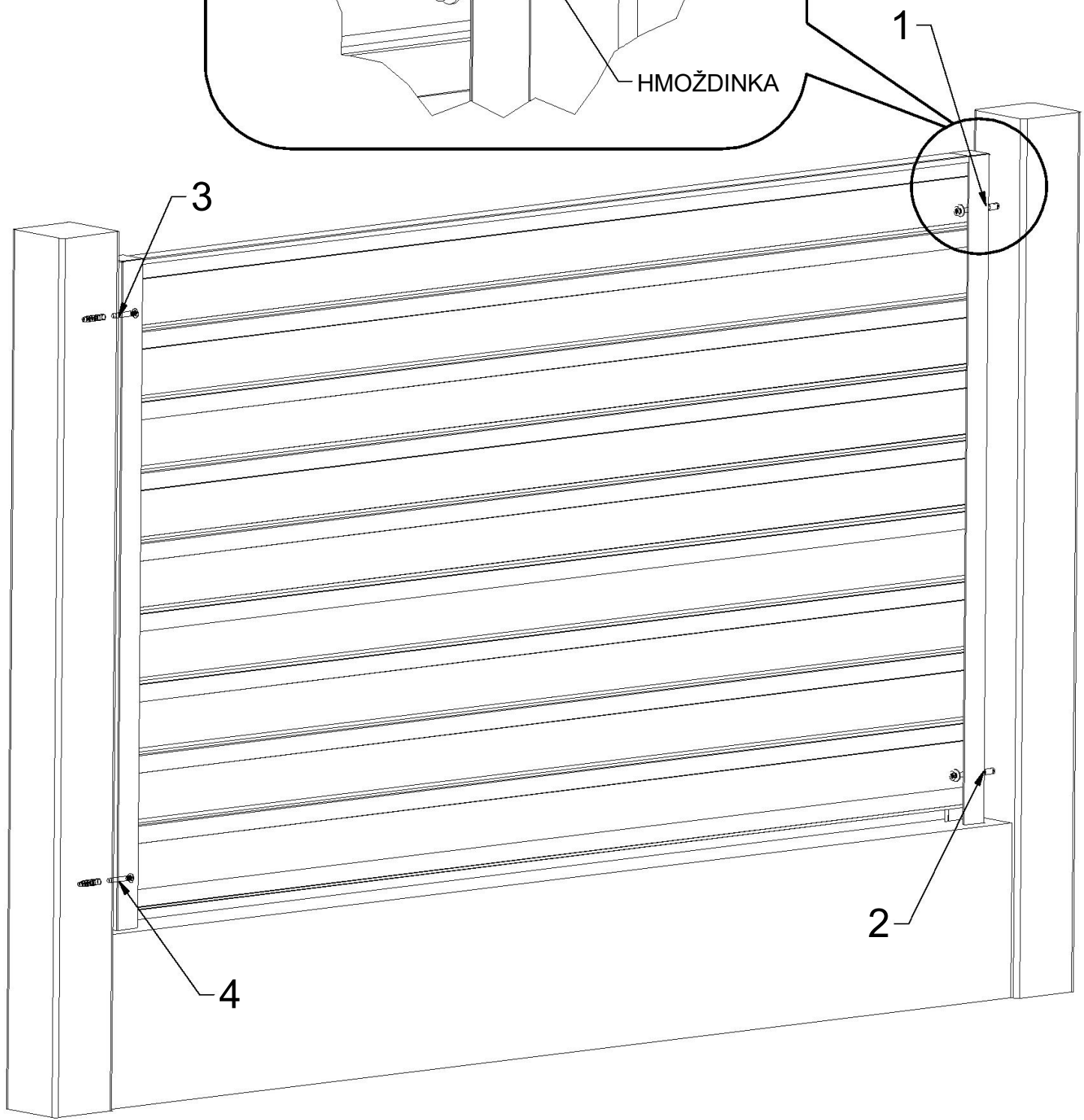
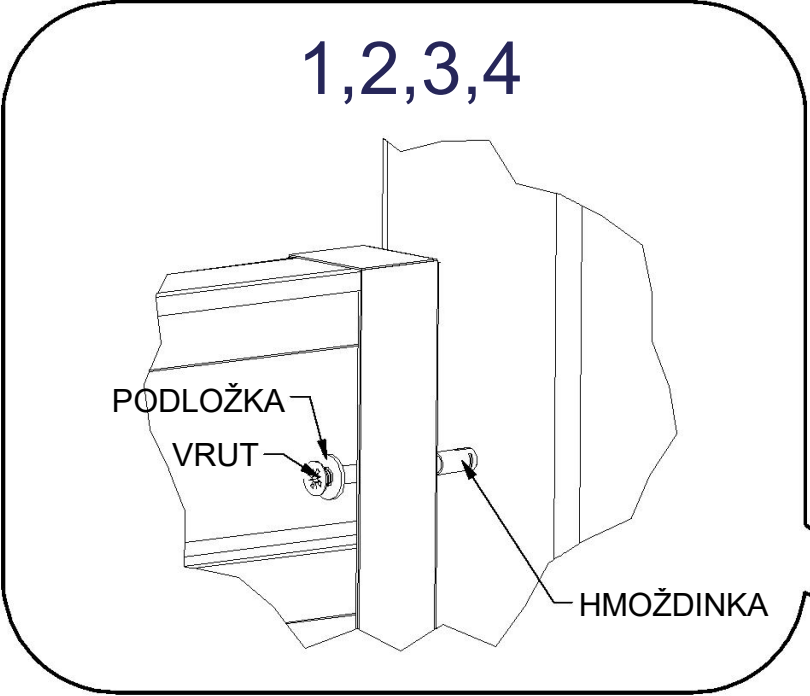

POHĽAD Z PROTIĽAHLEJ STRANY