

















| | | | | | | | |
|--|---|--|---|---|---|---|---|
|  Ø8 × 35 |  8x |  Ø8 × 24 |  8x |  4x |  4x |  4x |  4x |
| A 18x | B 8x | C 8x | D 8x | E 4x | F 4x | G 4x | H 4x |
|  Ø8 × 27 |  4x |  4x |  Ø3,5 × 16 12x |  2x |  1x |  1x |  2x |
| I 4x | J 4x | K 4x | L 12x | M 2x | N 1x | O 1x | P 2x |



1

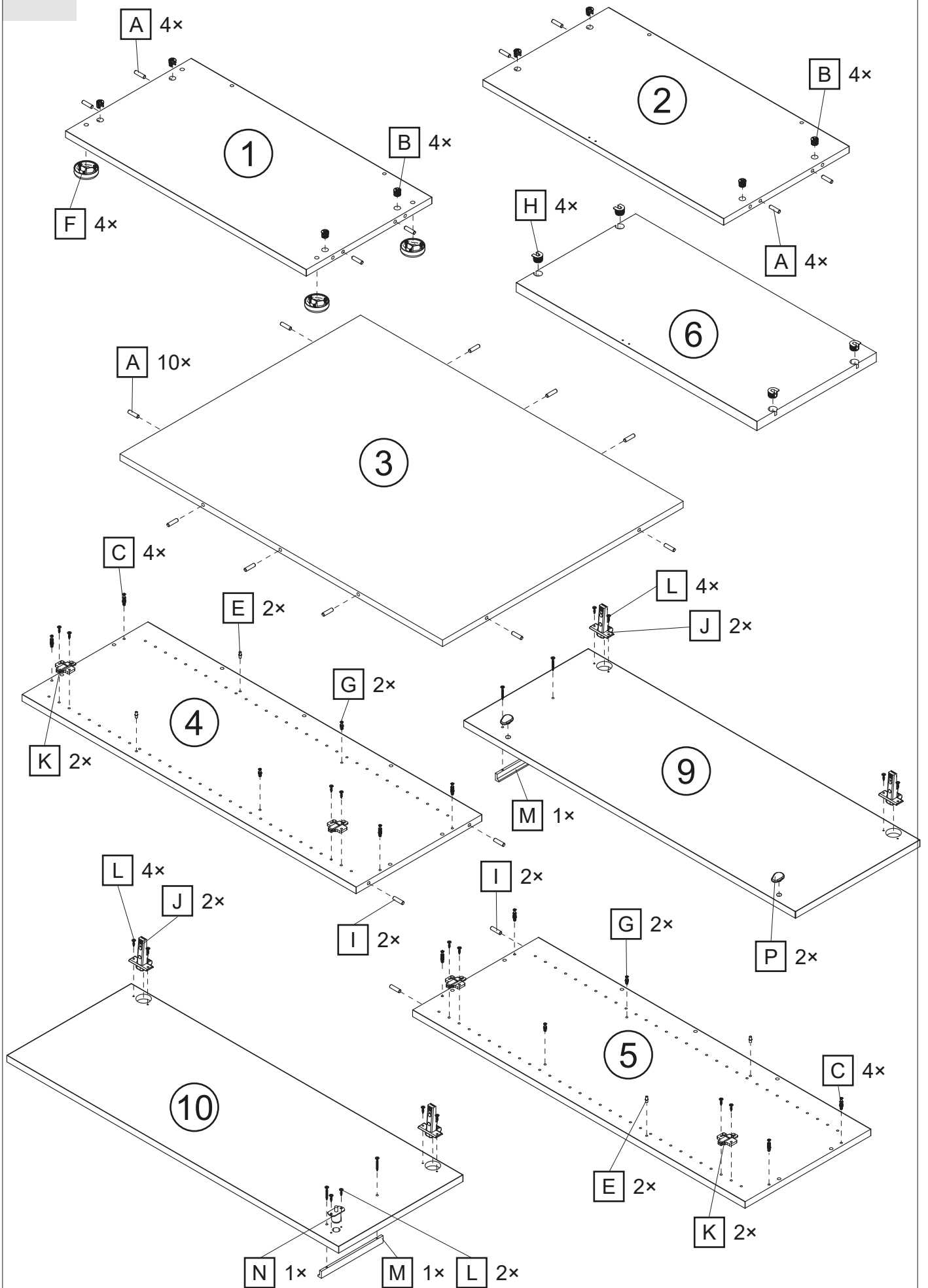

2

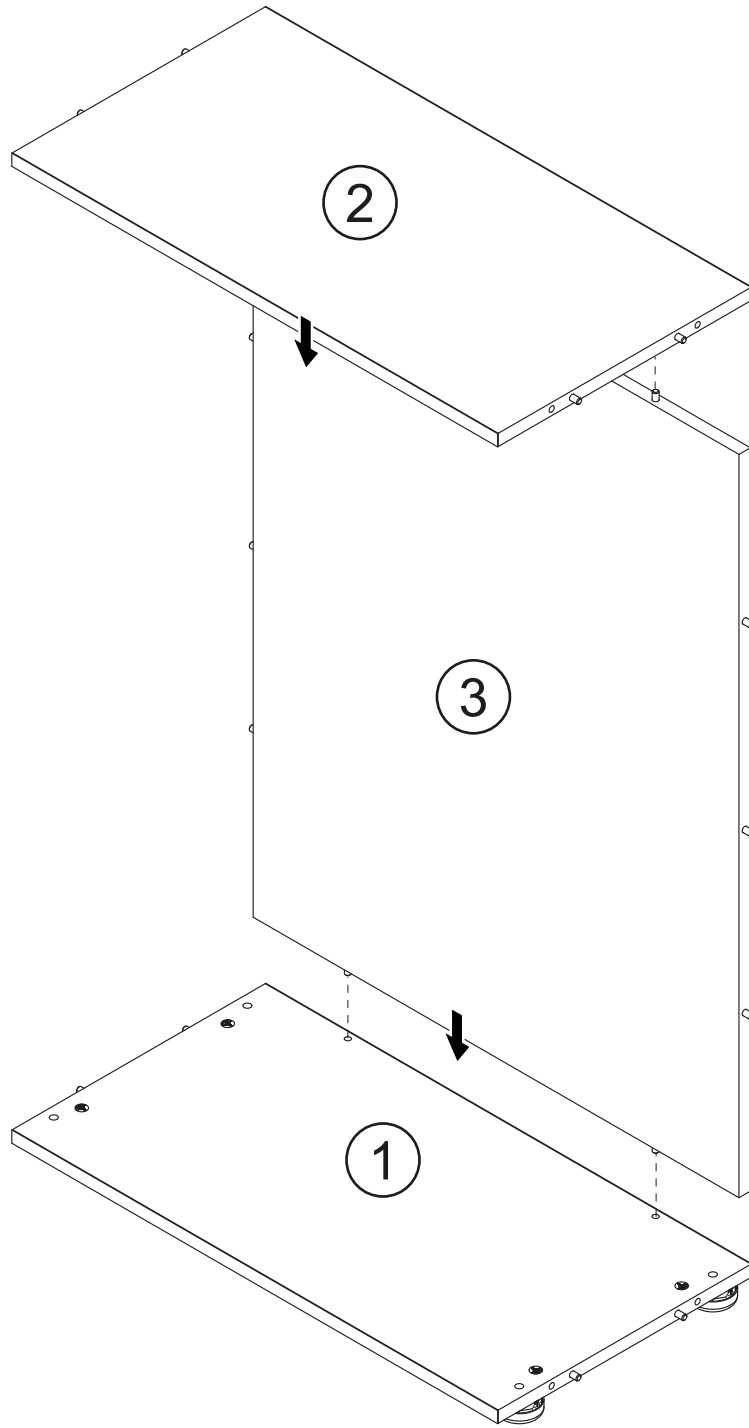

3

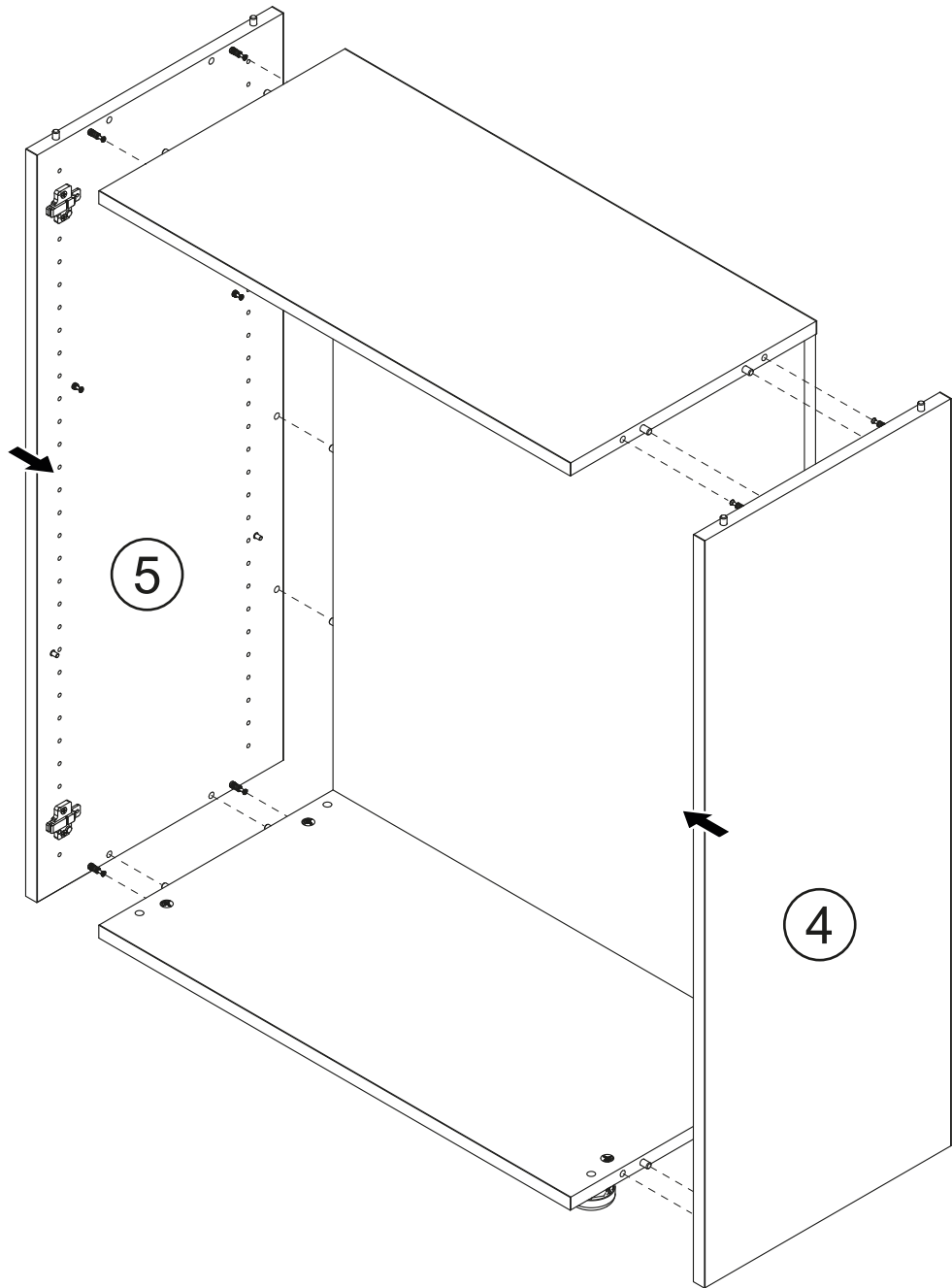

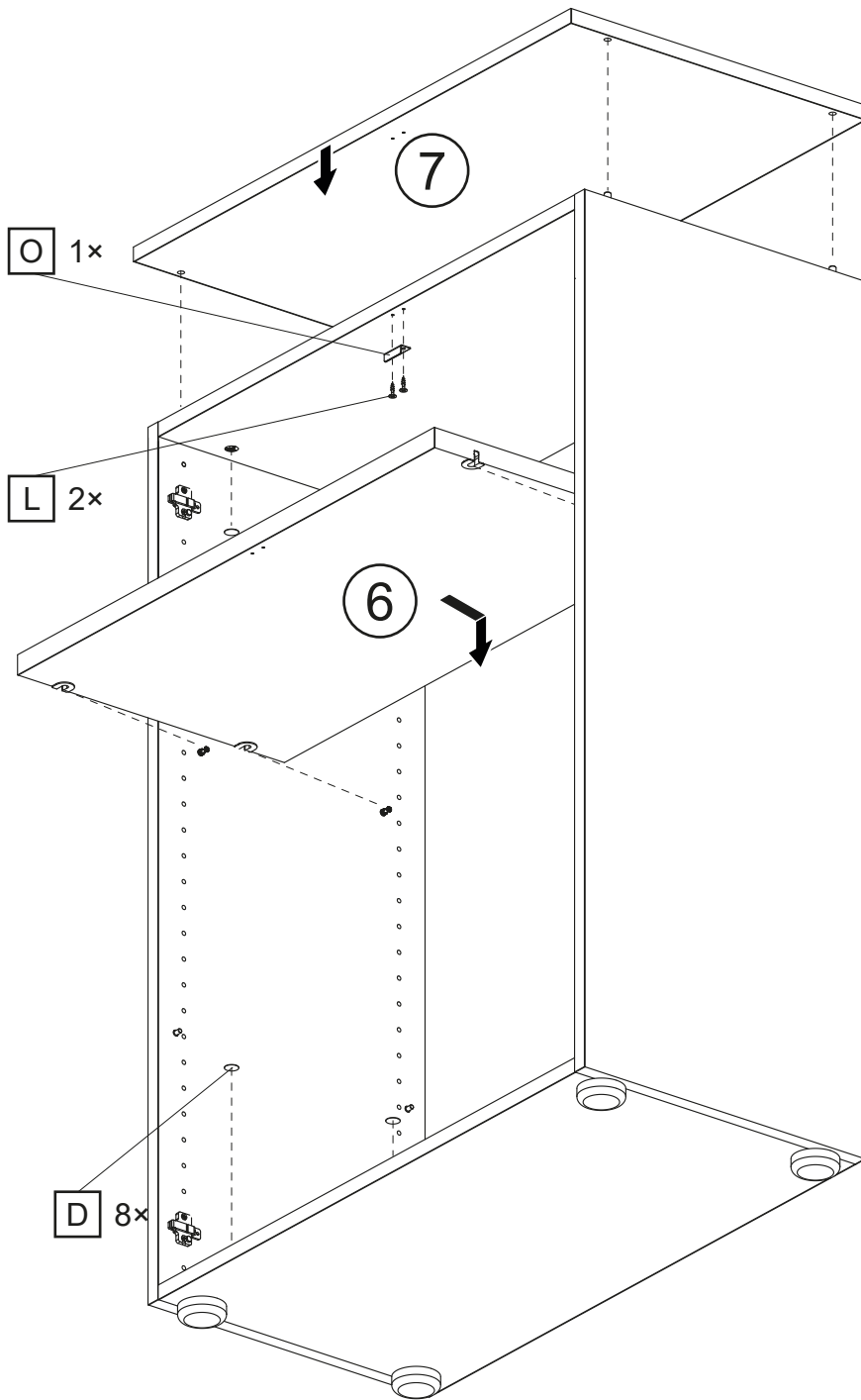

5

