















A		L=1200/1400/1600	1x	I			2x
B		L=400	2x	J			2x
C		L=200\300\400	1 unit in each	K			2x
D			4x	L		M8*12	4x
E		M3	1x	M		M12*50	2x
F				N		M5	1x
G			2x	O		M6	1x
H			2x	P		M8	1x

1. 



2. 

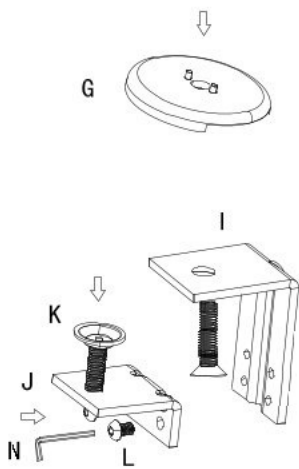
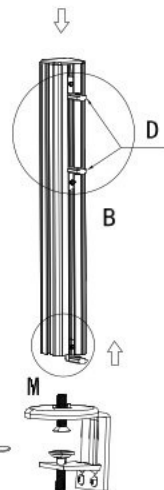
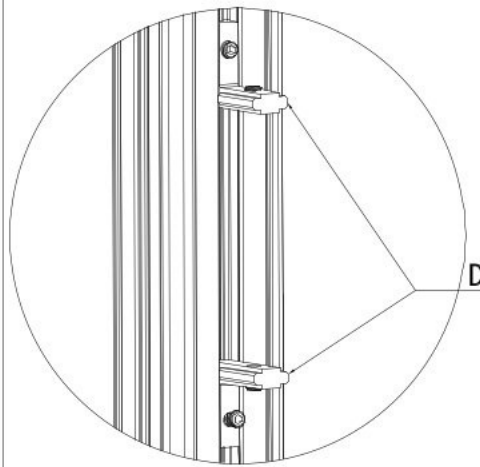

3.

