

(A) (1)

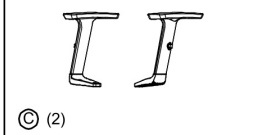

(B) (1)



(C) (2)

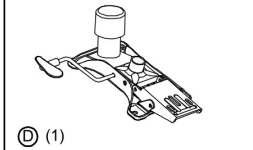

(D) (1)



(E) (1)

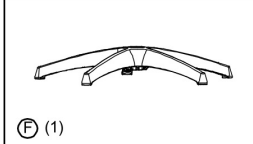

(F) (1)

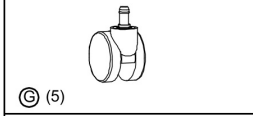

(G) (5)

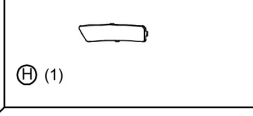

(H) (1)

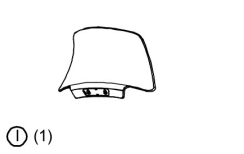

(I) (1)

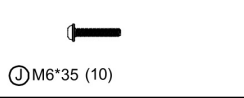

(J) M6*35 (10)



(K) M8*55 (3)

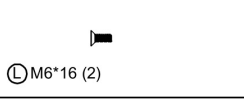

(L) M6*16 (2)

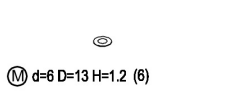

(M) d=6 D=13 H=1.2 (6)

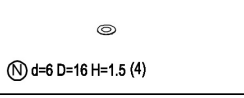

(N) d=6 D=16 H=1.5 (4)

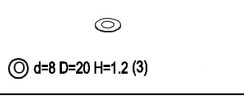

(O) d=8 D=20 H=1.2 (3)

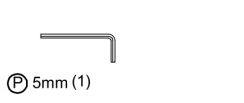

(P) 5mm (1)

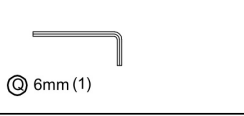

(Q) 6mm (1)

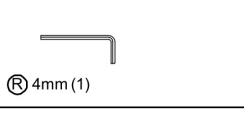

(R) 4mm (1)

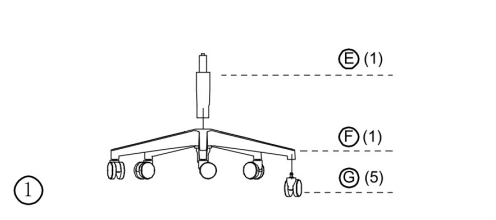

(1)

(E) (1)

(F) (1)

(G) (5)

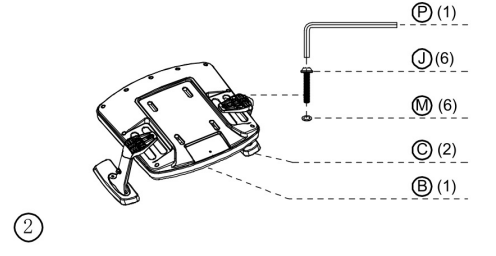

(2)

(P) (1)

(J) (6)

(M) (6)

(C) (2)

(B) (1)

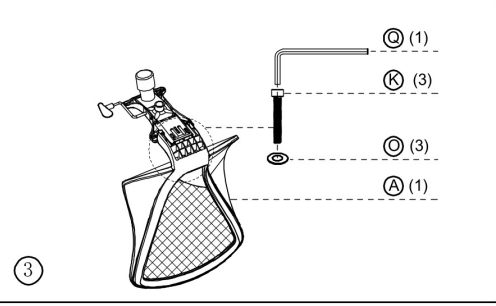

(3)

(Q) (1)

(K) (3)

(O) (3)

(A) (1)

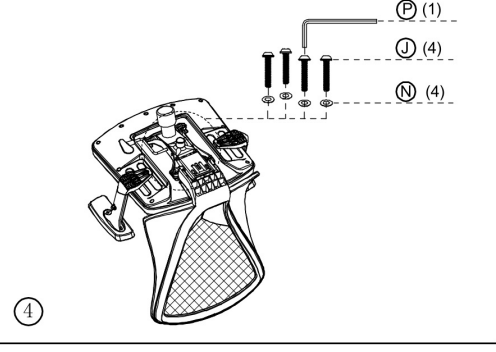

(4)

(P) (1)

(J) (4)

(N) (4)



(5)

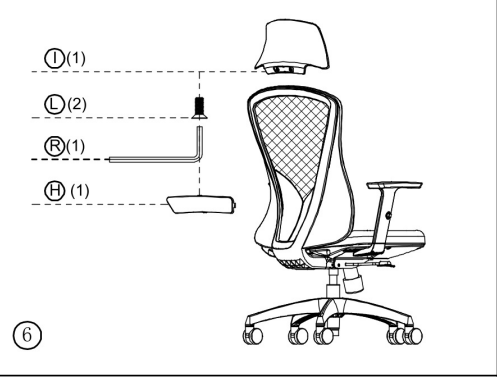

(6)

(I) (1)

(L) (2)

(R) (1)

(H) (1)



(7)

