

	
Ø8 × 35		Ø8 × 24						
A 26×	B 12×	C 12×	D 12×	E 16×	F 16×	G 5×	H 8×	
								
		Ø3,5 × 16						
I 8×	J 2×	K 36×						



1



2

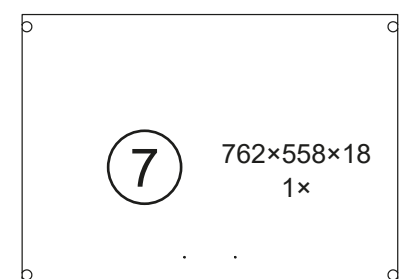
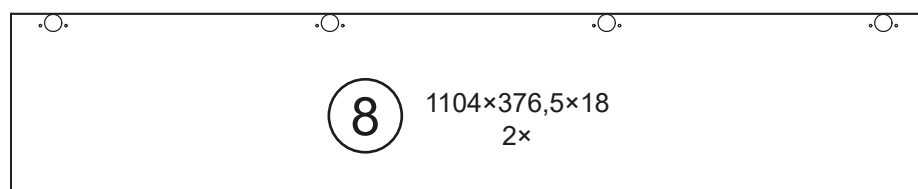
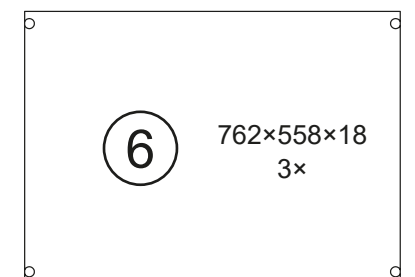
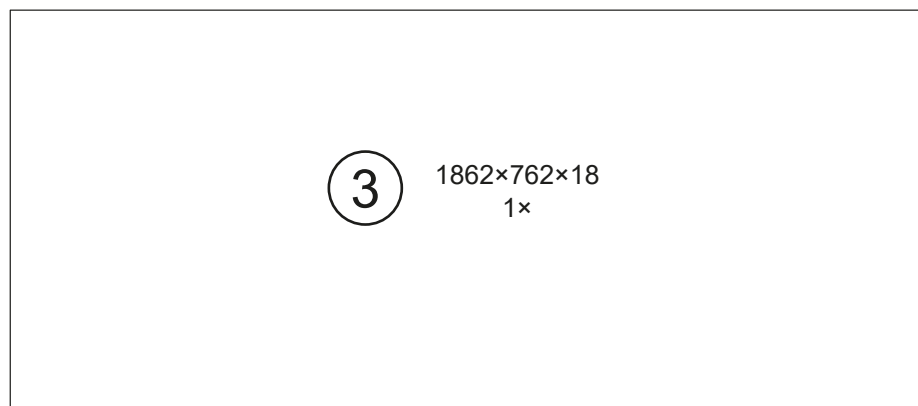
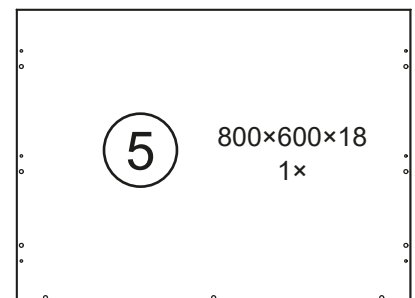
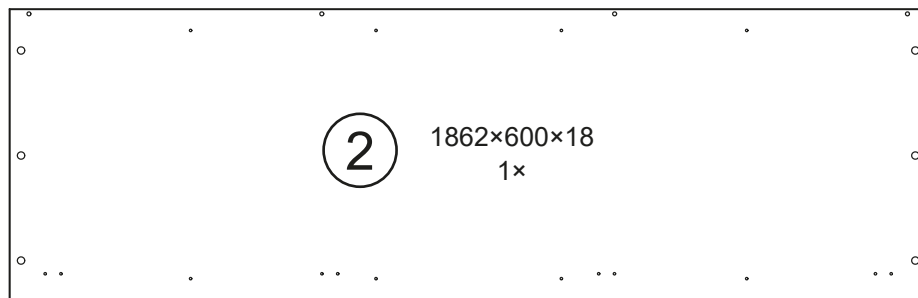
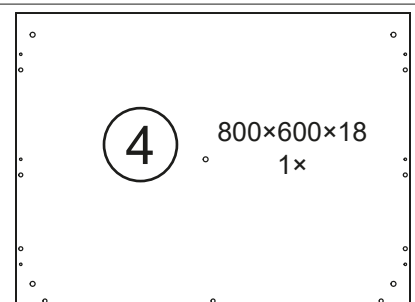
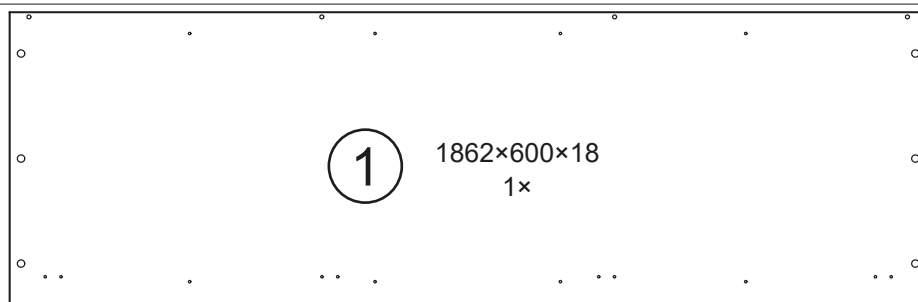
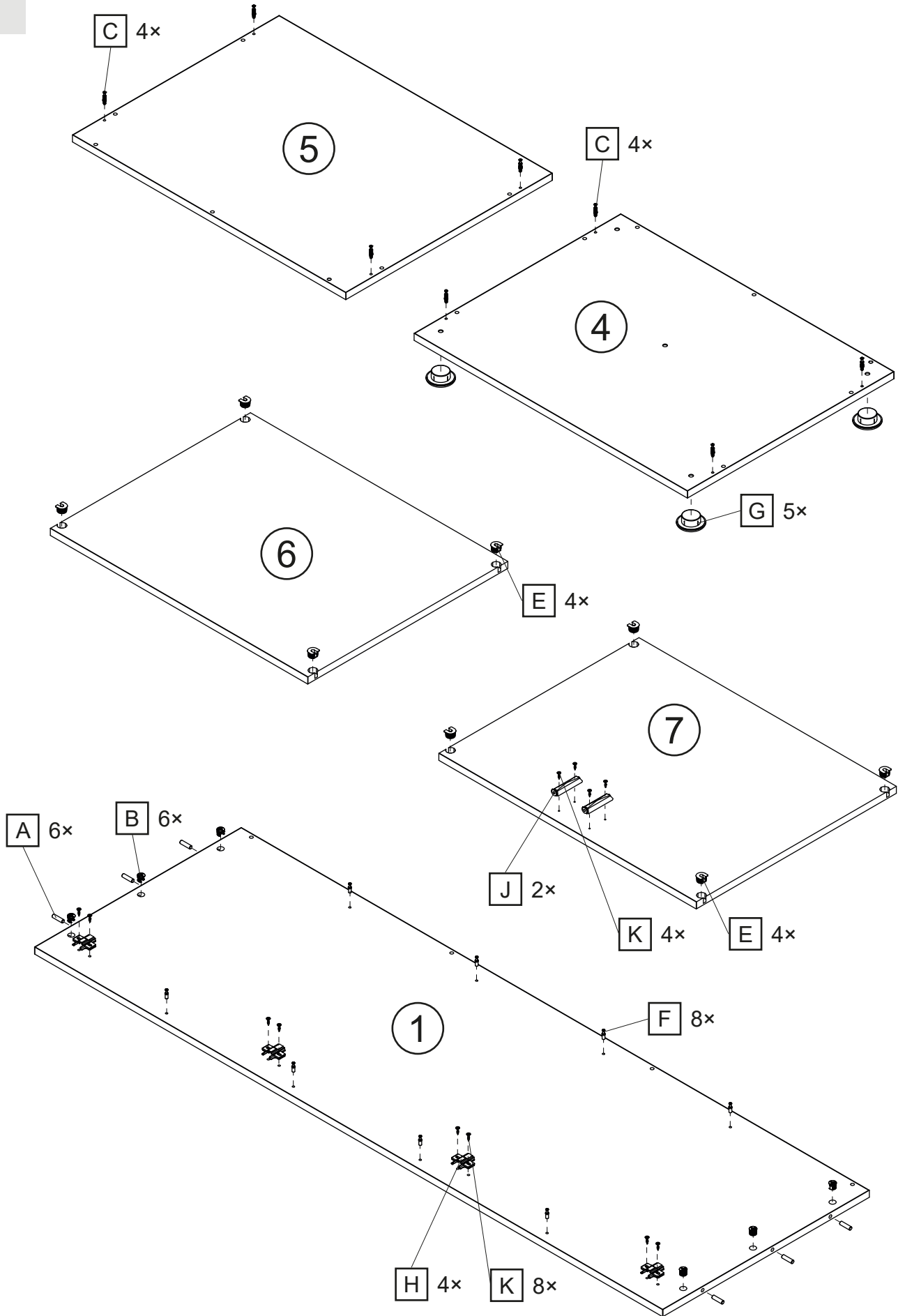
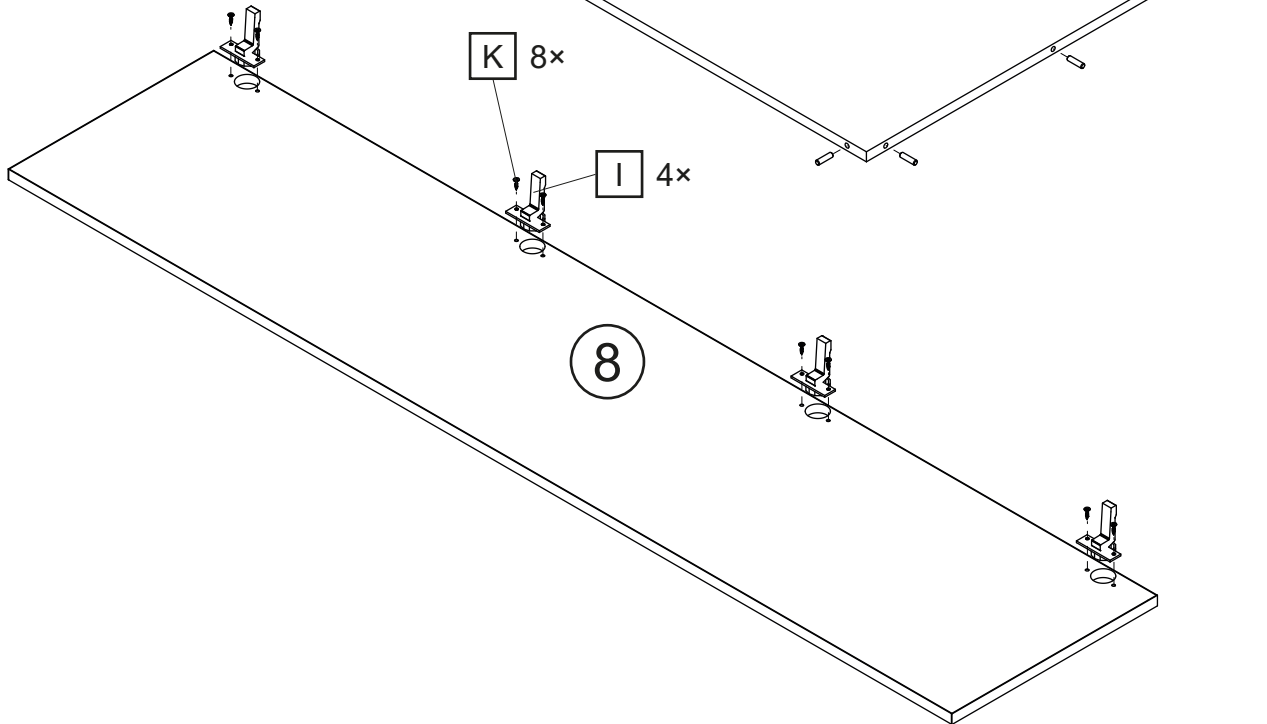
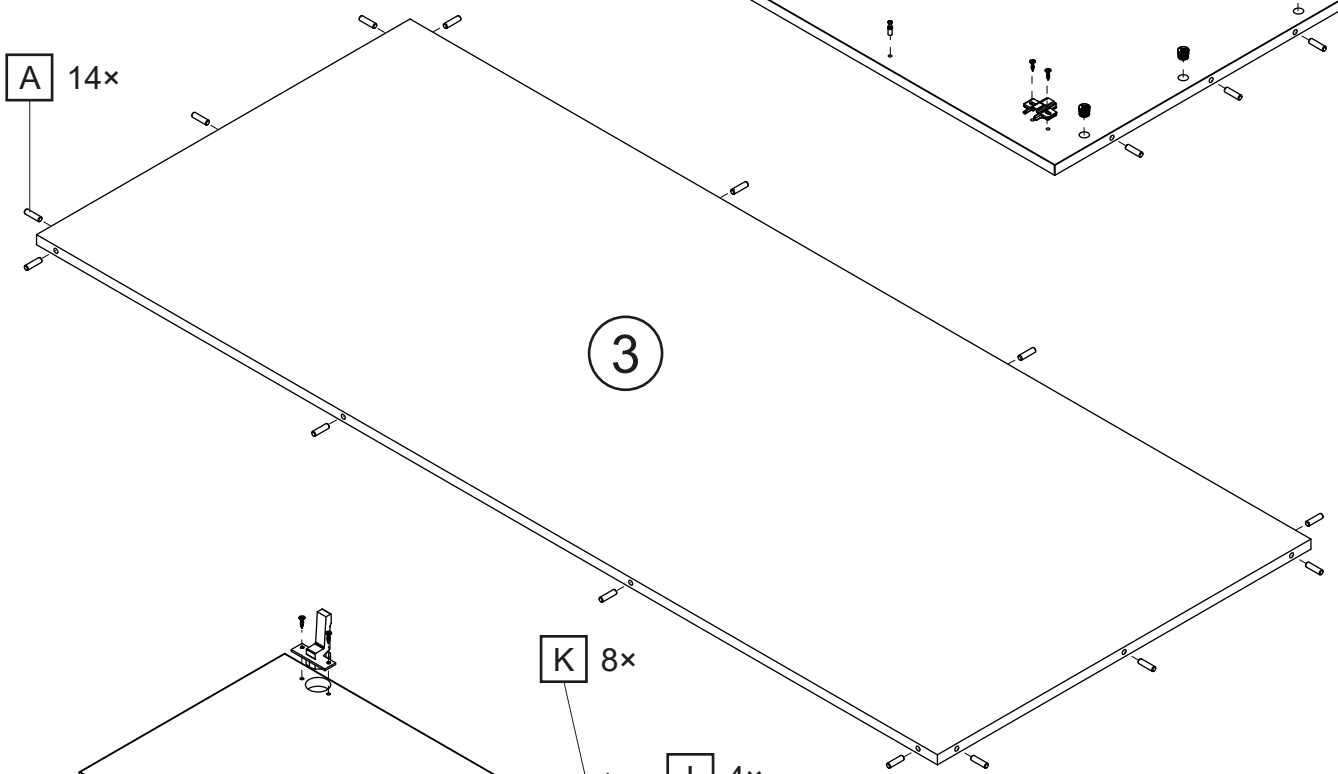
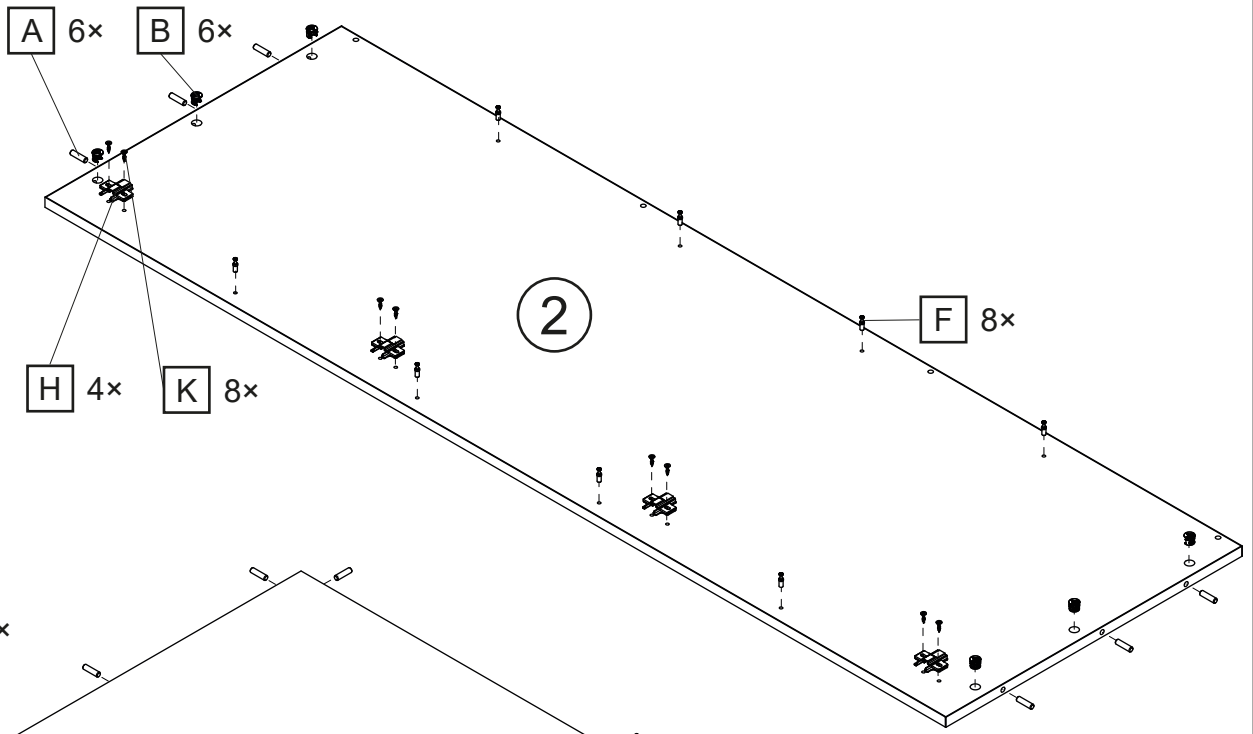

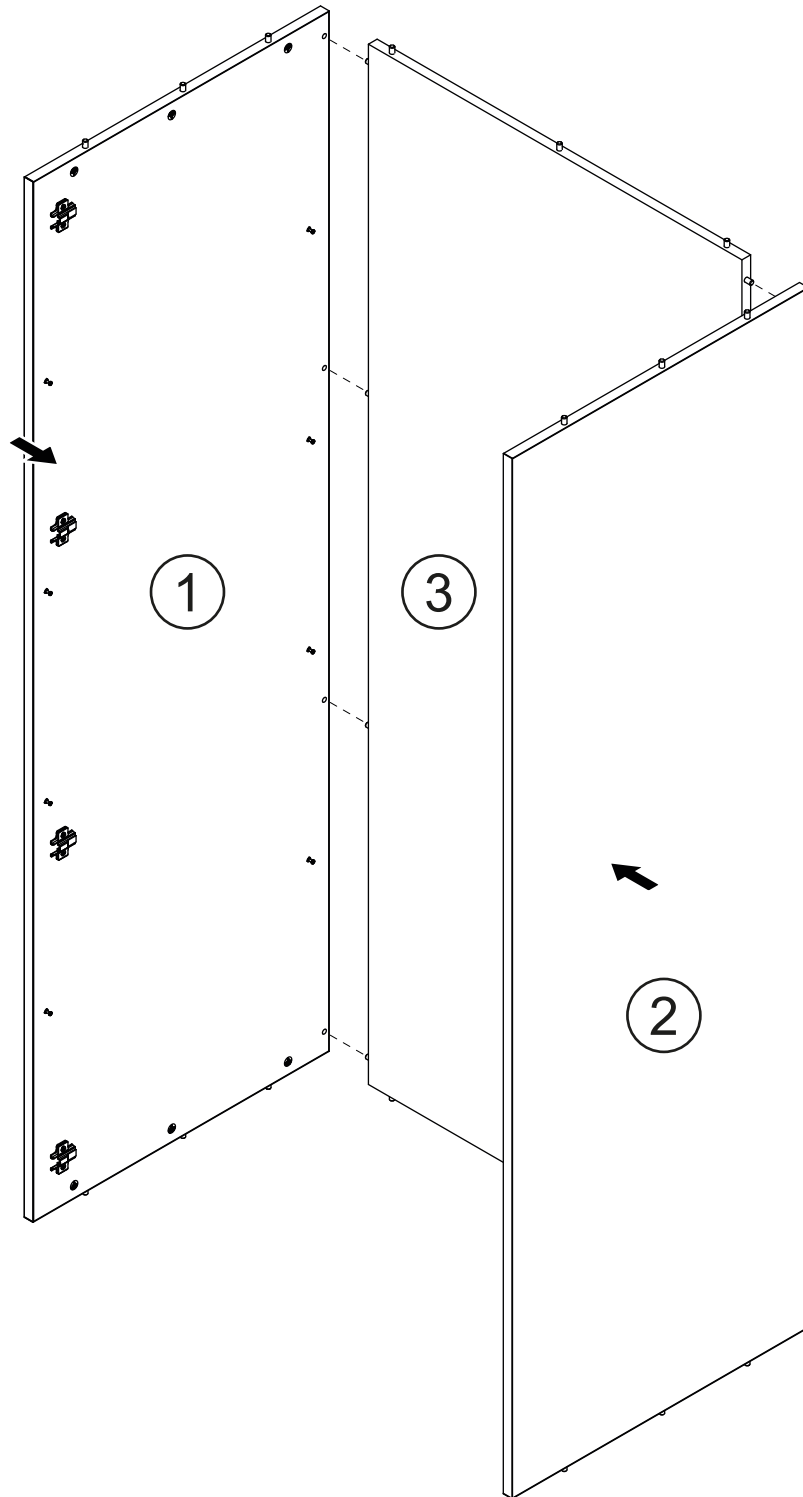

4

