









 Ø8 × 35	 8x	 Ø8 × 24	 8x	 16x	 16x	 5x	 8x	
A 22x	B 8x	C 8x	D 8x	E 16x	F 16x	G 5x	H 8x	
 8x	 2x	 Ø3,5 × 16 36x						
I 8x	J 2x	K 36x						



1



2

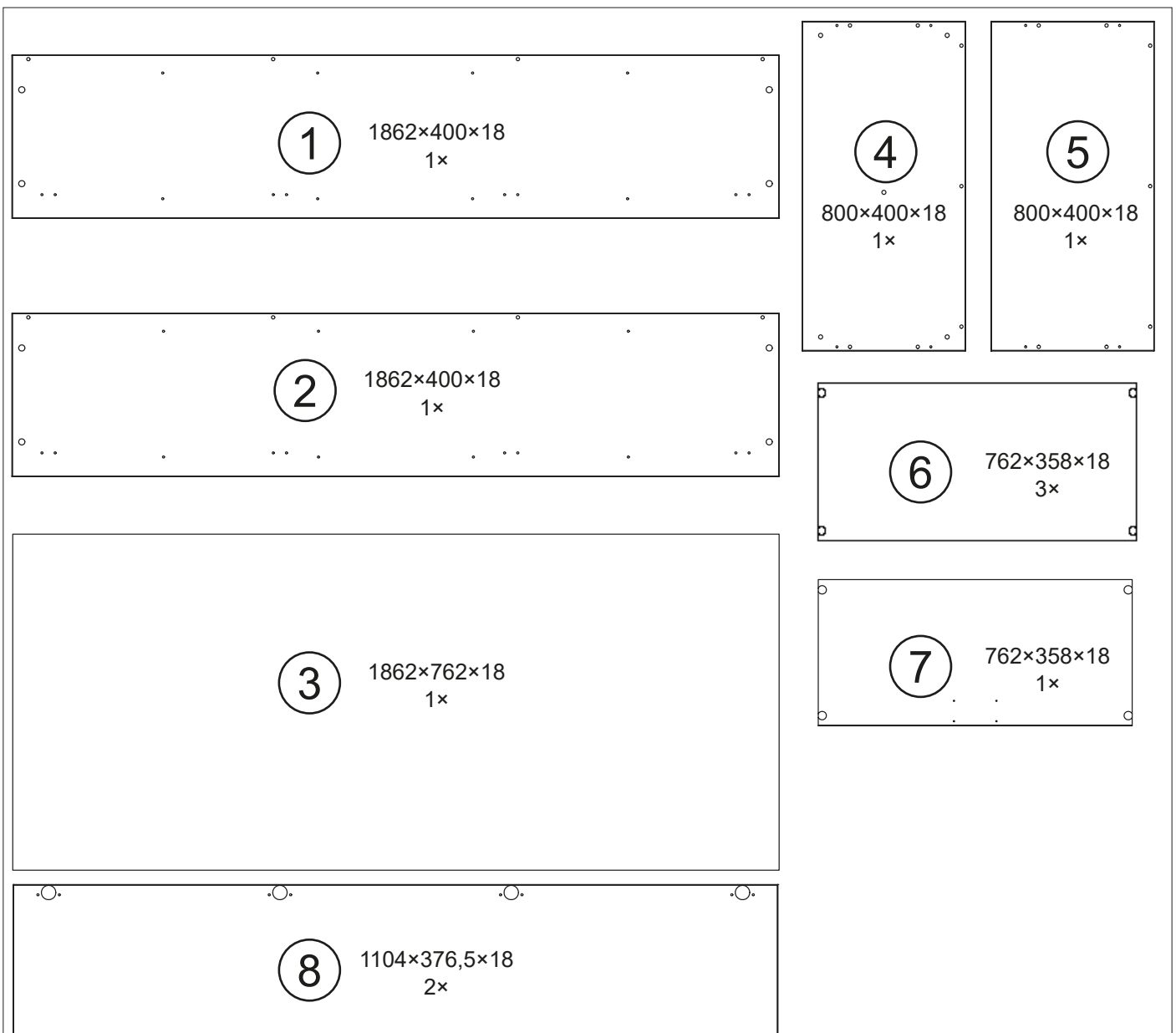
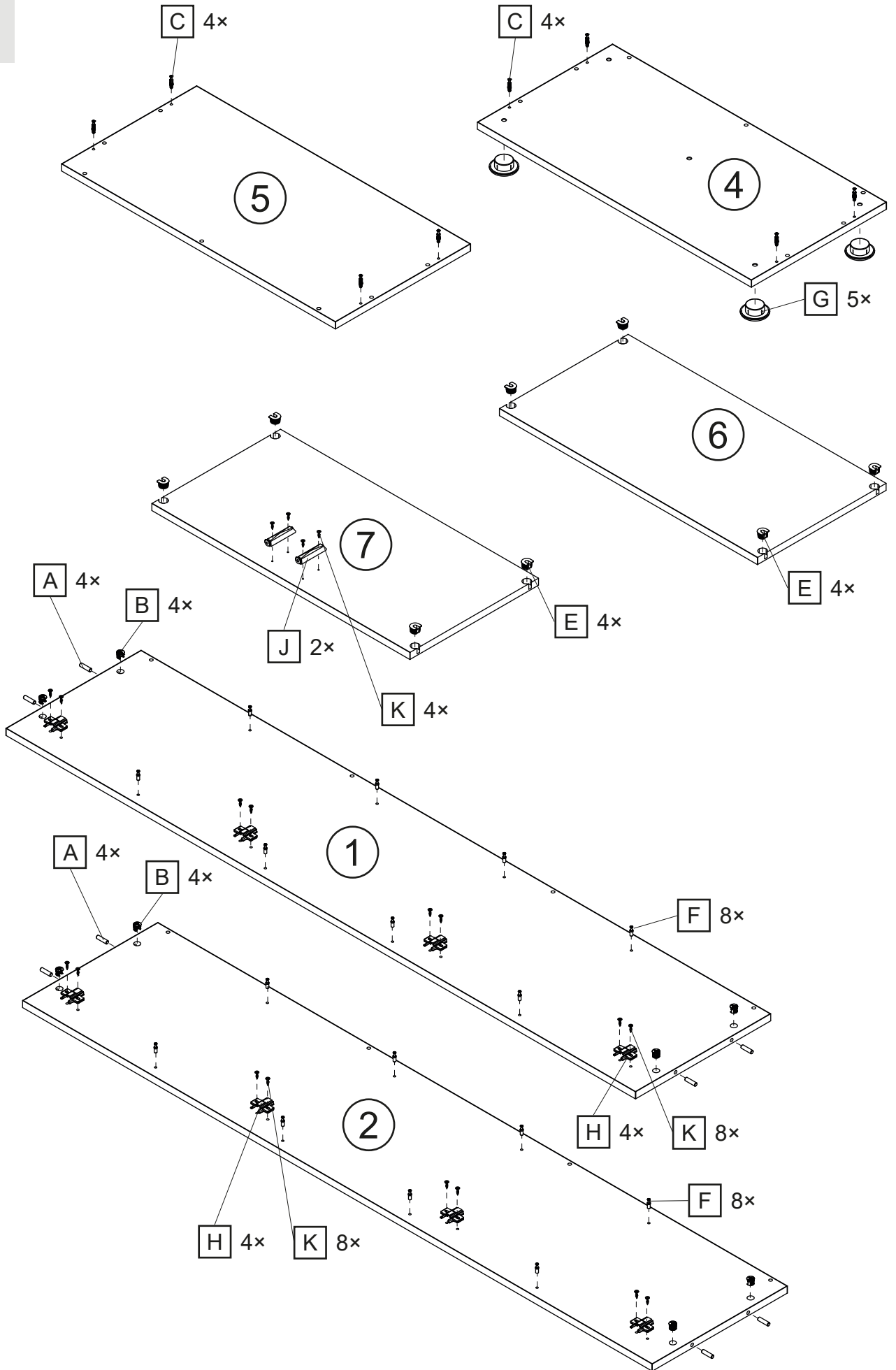
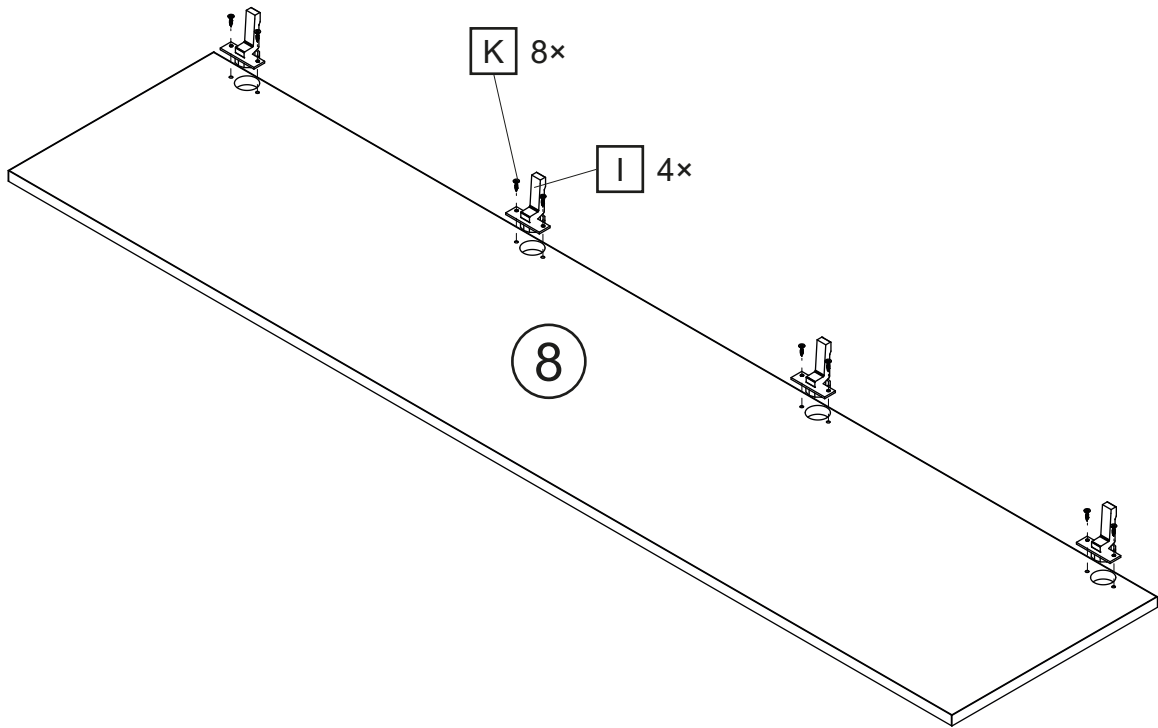
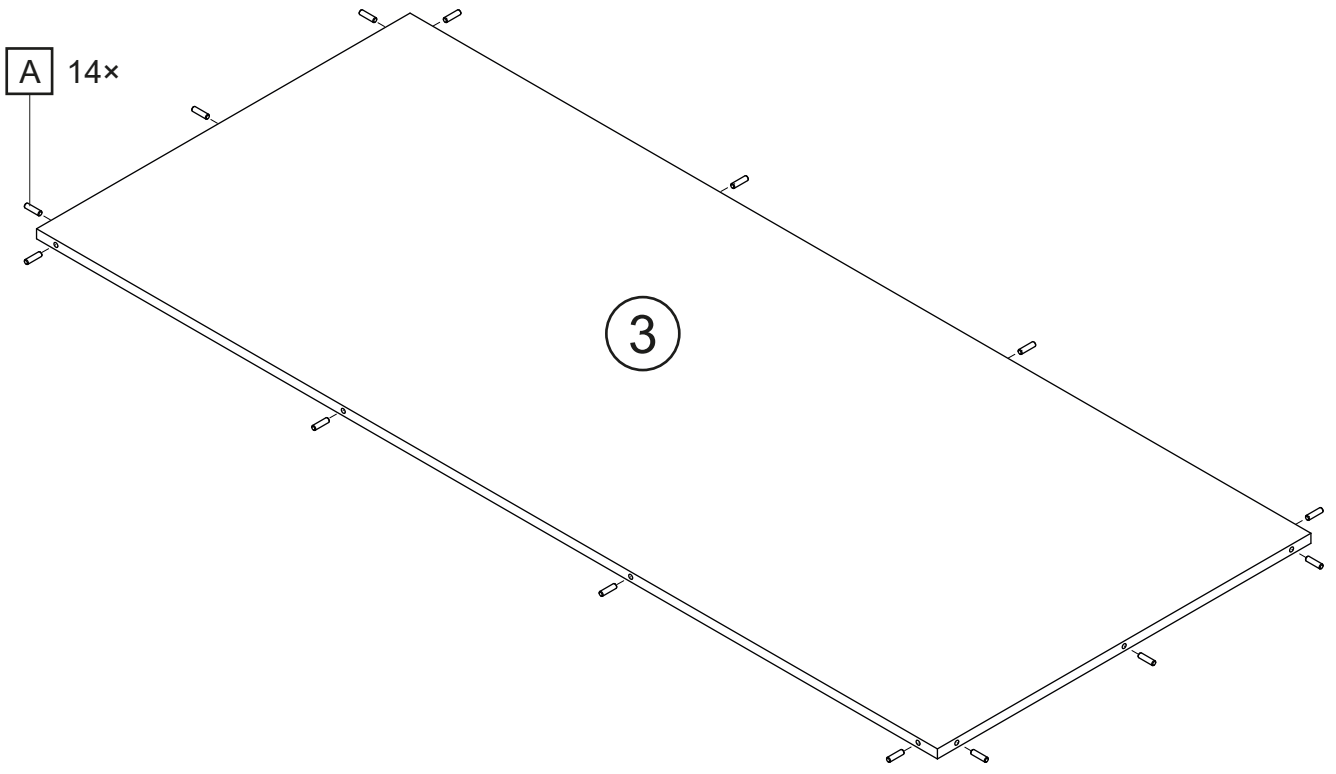

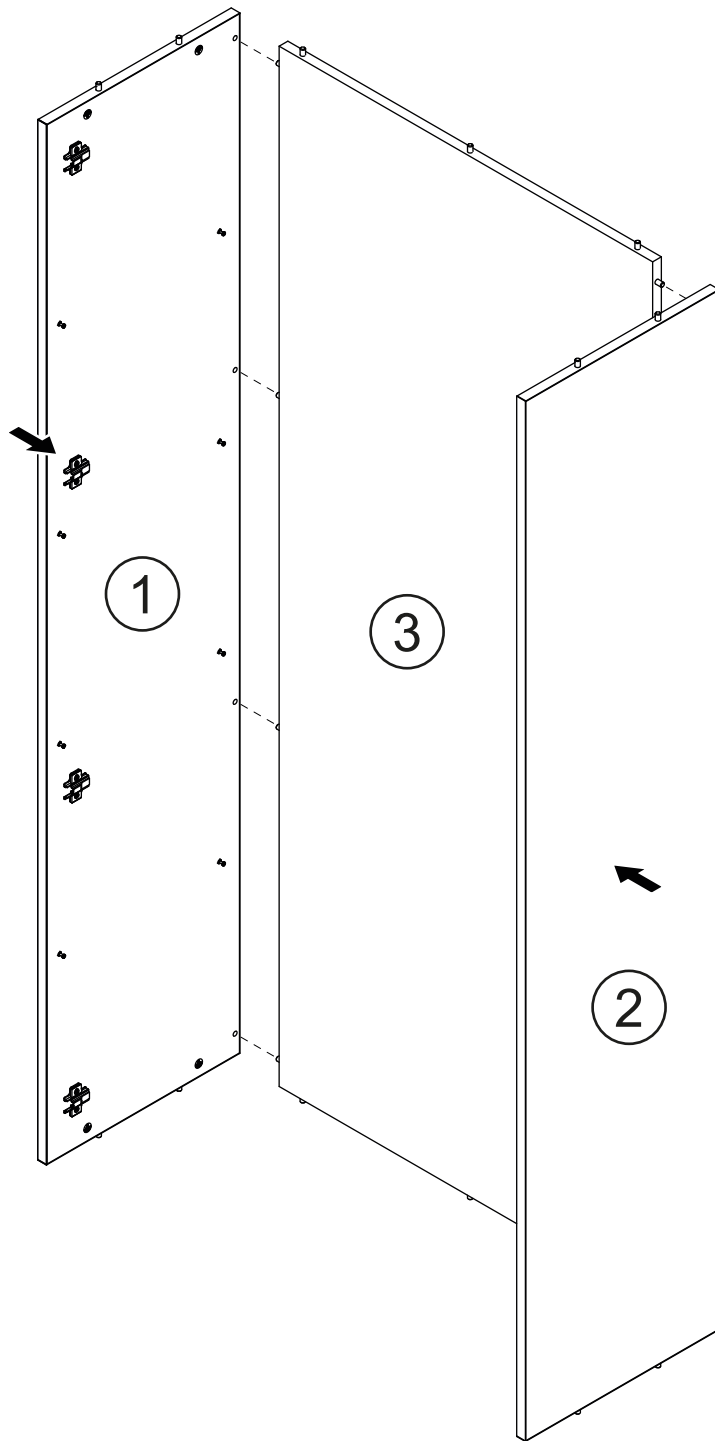

4

