

Ø8 × 35					Ø3,5 × 16
A 26×	B 14×	C 14×	D 14×	E 2×	F 8×

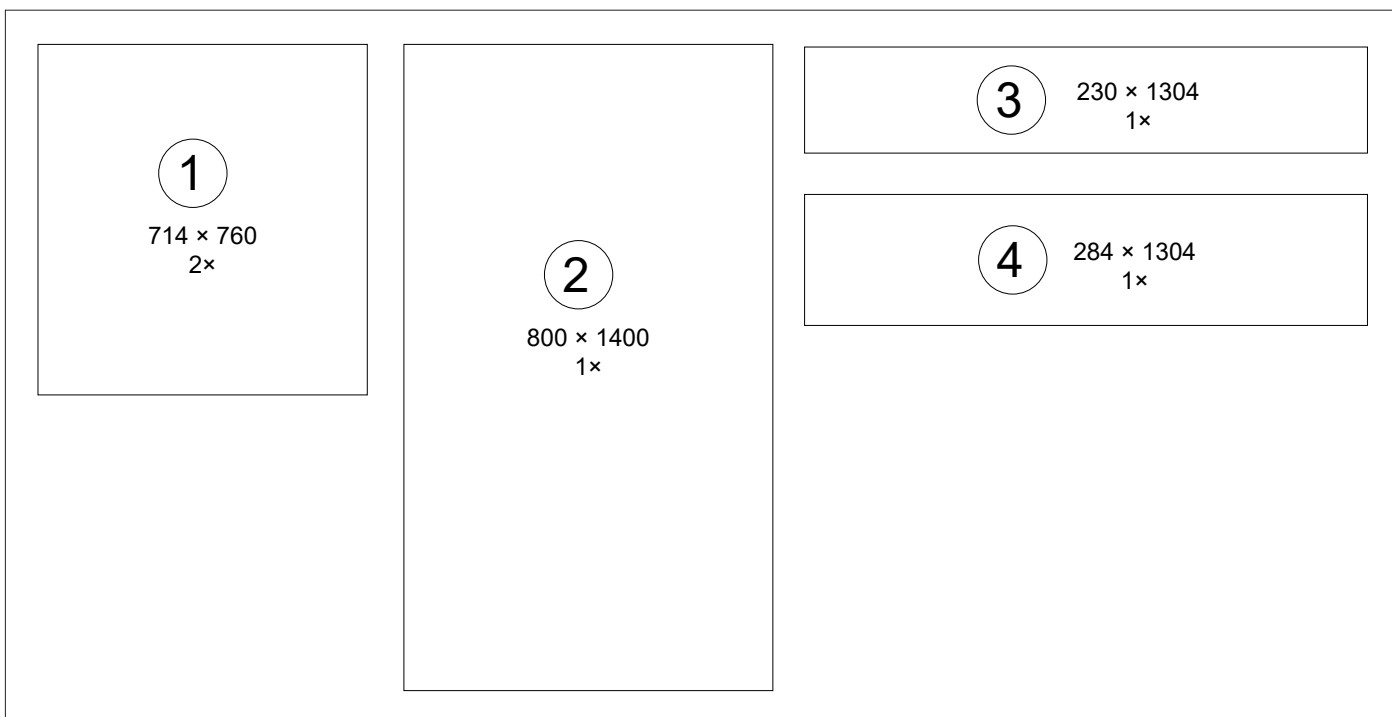

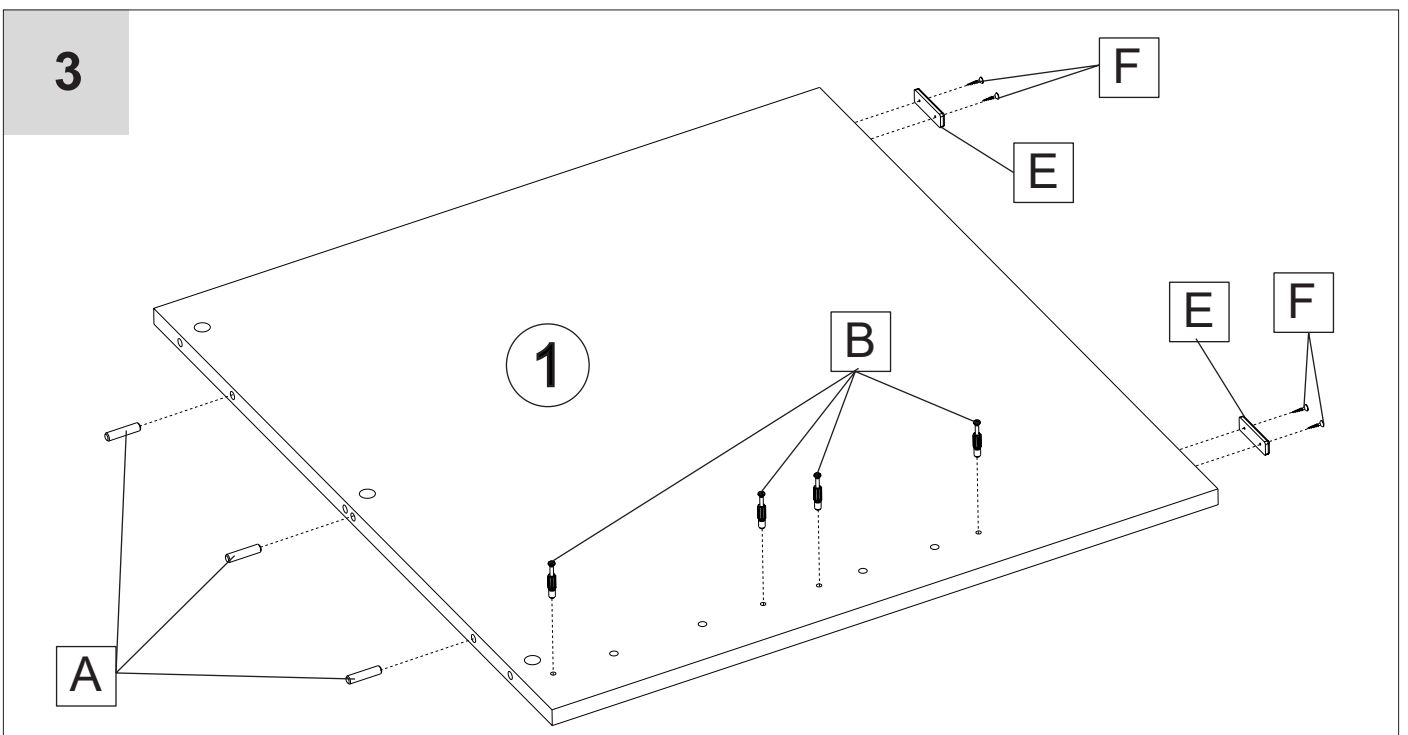

4

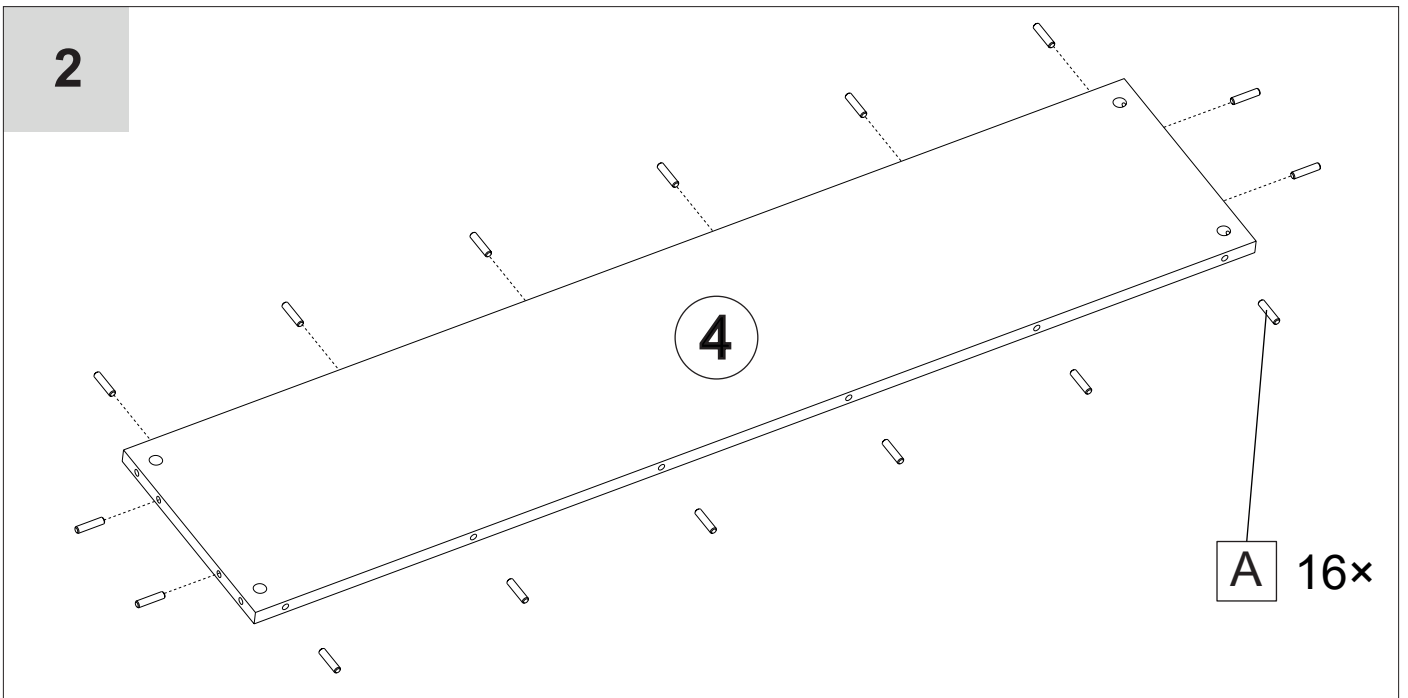
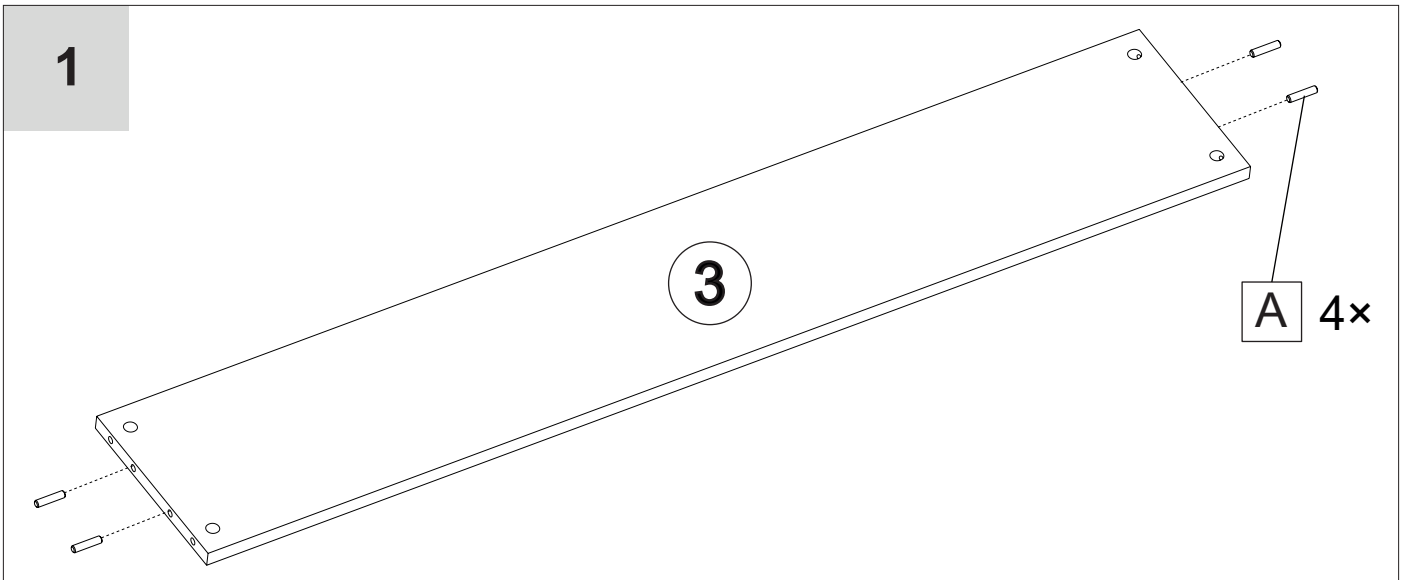
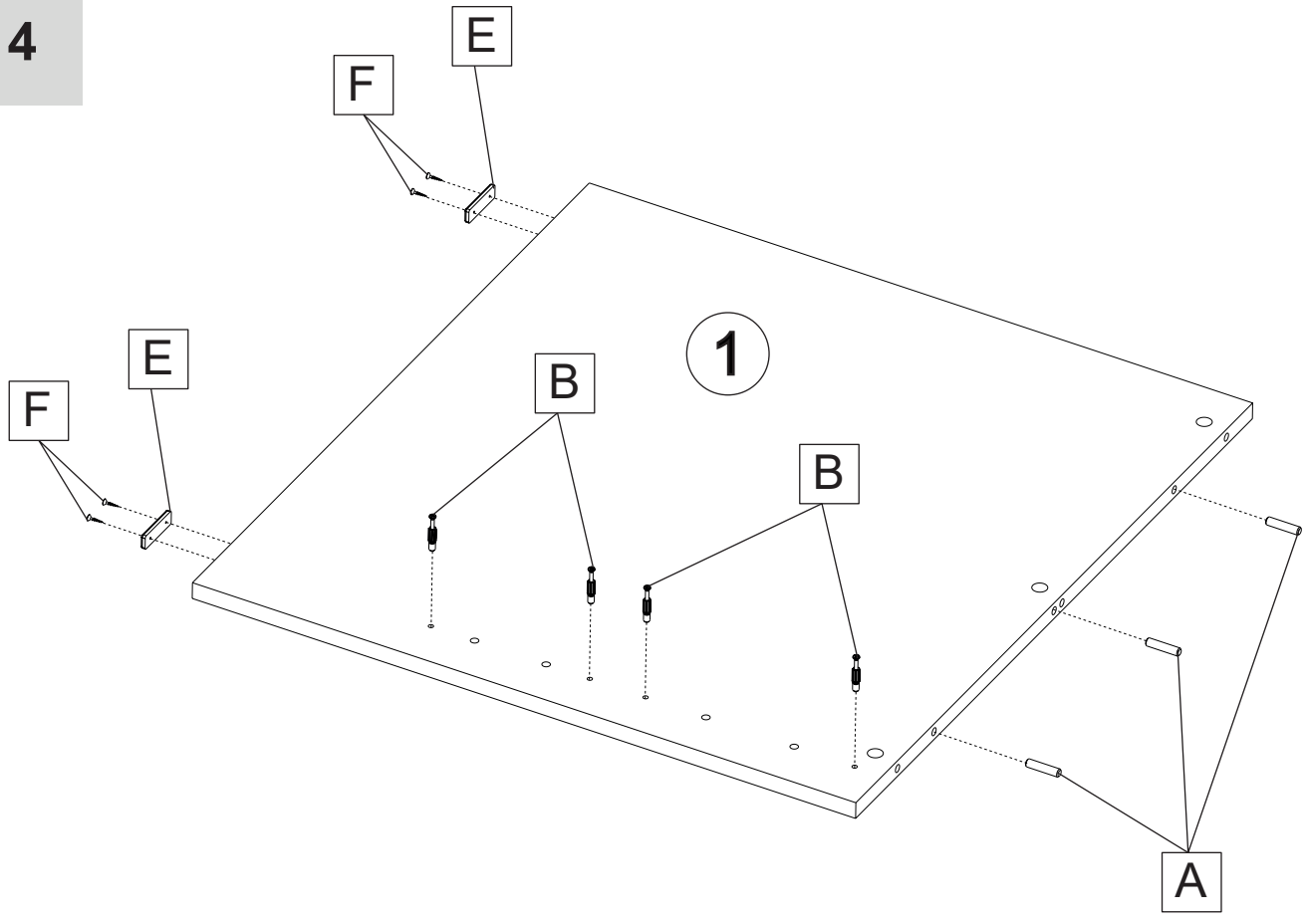

5

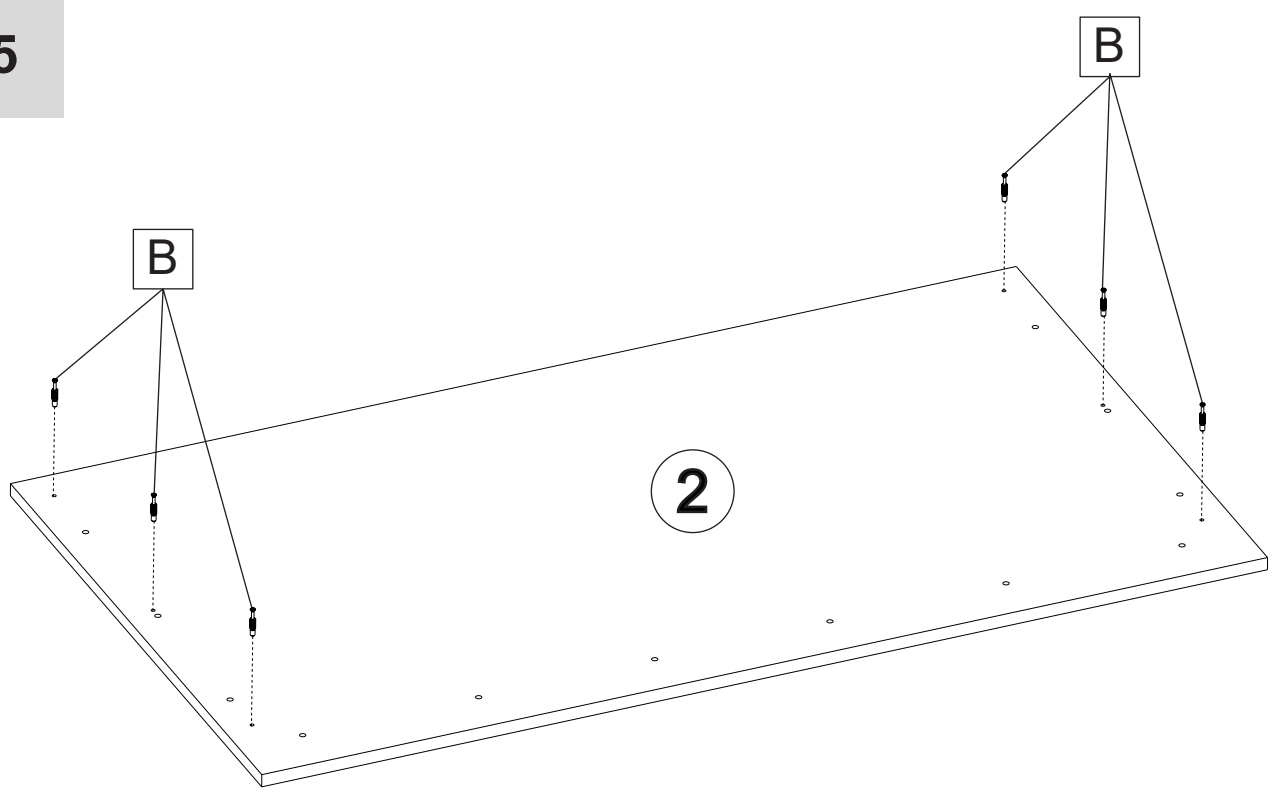

6

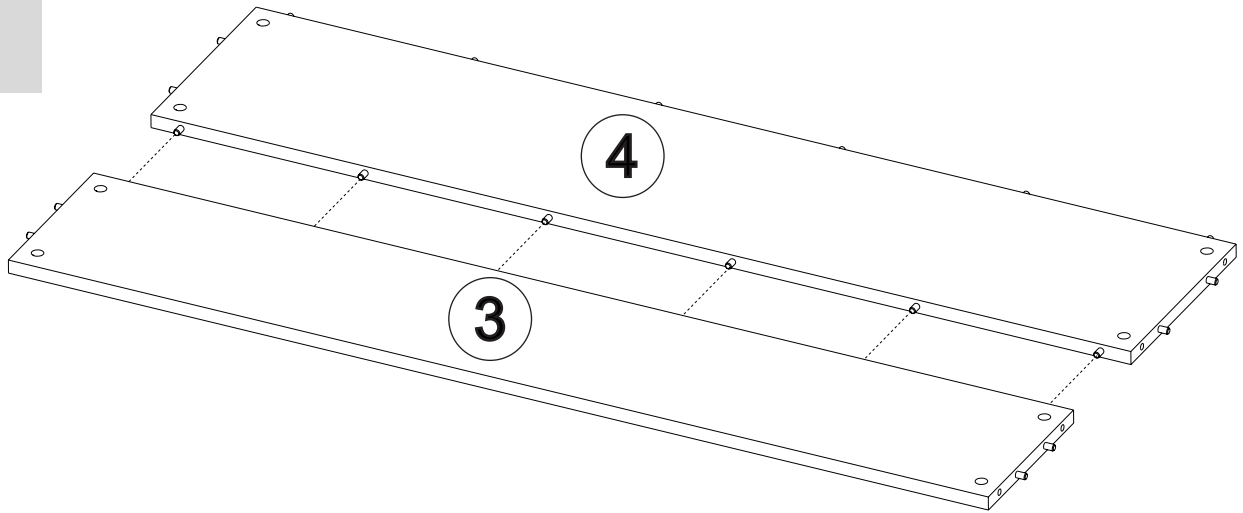

7

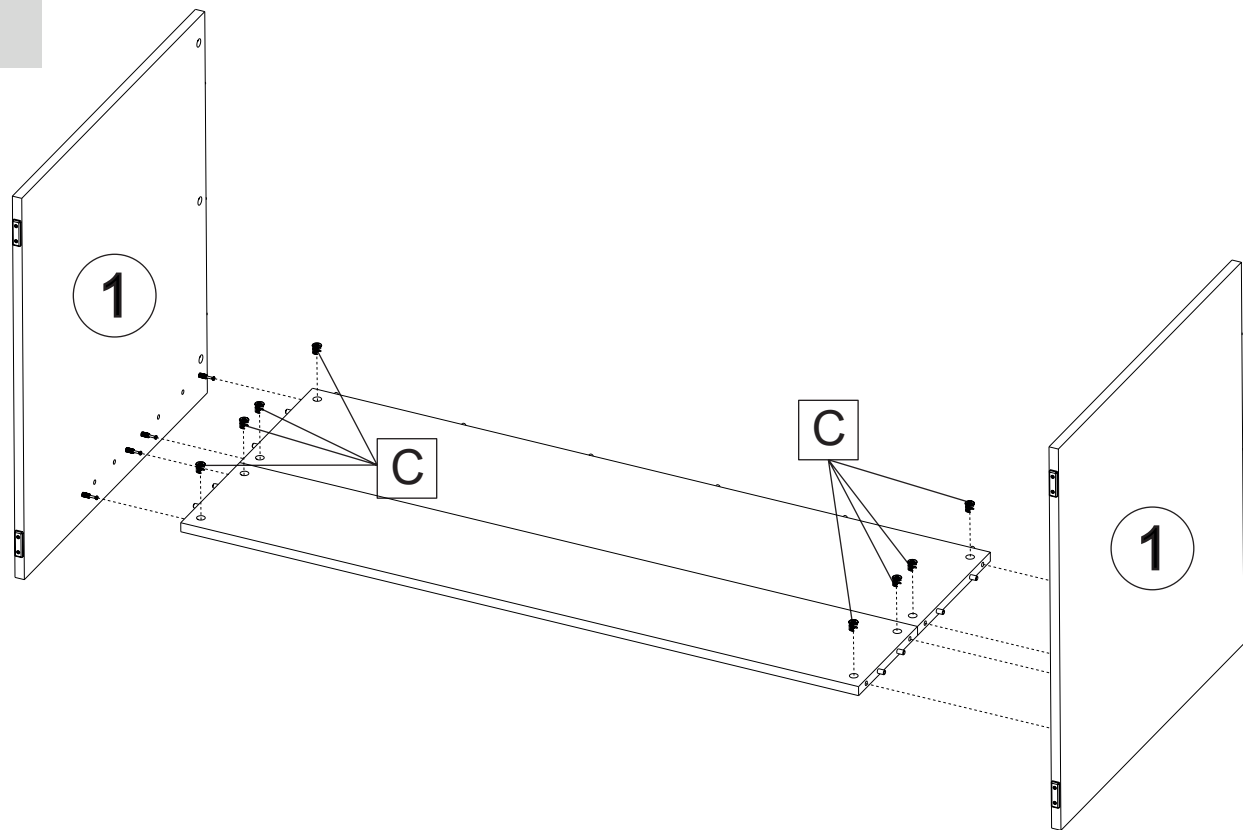

8

