

1.

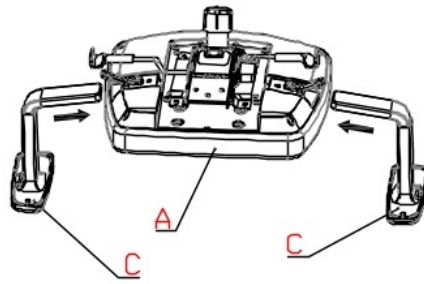

3.

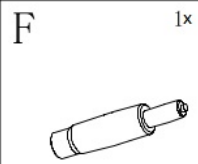
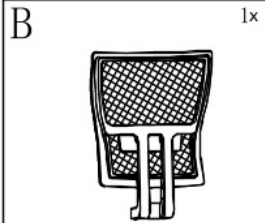
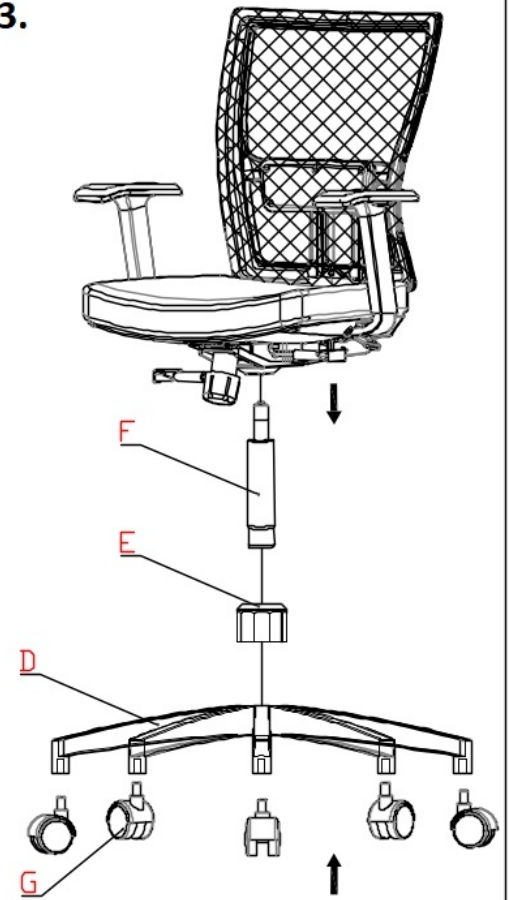

2.

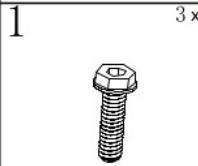
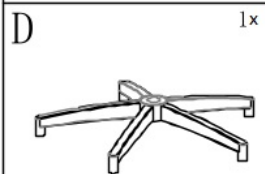
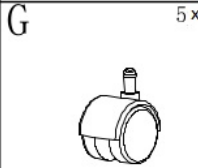
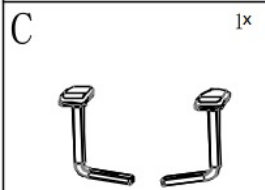
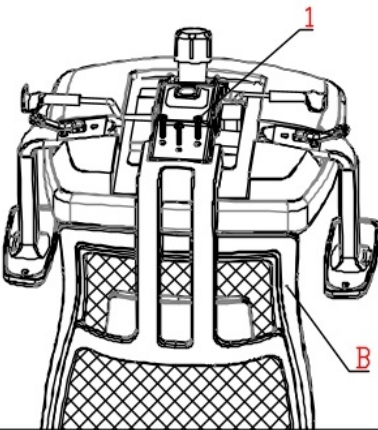

8X45

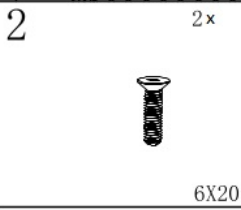

4.

